

MDU PRODUCT APPLICATIONS



Accelerating Cost-Effective
Fiber Fed Deployments



CLEARFIELD
SeeClearfield.com

Characterized by flexibility, scalability and fiber protection, Clearfield's multi-dwelling unit product offerings are designed to be craft-friendly — reducing the time necessary to install the network. Speed of installation is maximized by using existing infrastructure, implementing end-to-end plug-and-play functionality, and interconnecting any type of pathway and media (conduit, microduct, flat fiber, microfiber).

MDU fiber optic deployments come in many different forms and for this reason, are some of the most challenging deployments for network providers. Ranging from single level townhome designs to low-rise garden style units to mid-rise and high-rise buildings, each have their own unique installation hurdles, yet all share the common need for deploying fiber quickly and easily to meet installation deadlines.

The Clearfield® MDU suite of products offer a simple solution to fit any type of MDU while providing easy-to-install, high quality connections that are easily repeatable, by any technician. Additionally, Clearfield MDU solutions require very few SKU's to complete any style of MDU structure, thus streamlining the ordering process.

By eliminating lengthy parts lists and reducing labor costs, providers are now able to install more units per day using any level of technician while ensuring the highest quality connections get made every time. The following pages illustrate how Clearfield products help you provide more services quicker, without sacrificing quality.

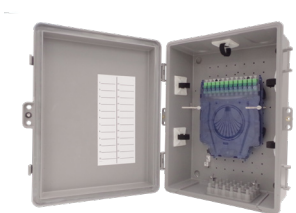

YOURx™ Flex Box

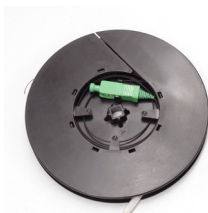

FieldShield® StrongFiber & Drop Wheel

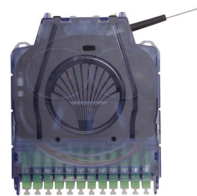

Clearview® Blue



Clearview xPAK



YOURx-Aerial Terminal



YOURx-Terminal



FieldSmart Indoor 288 FDP



Home Deployment Kit -
FieldSmart SCD-TAP



Home Deployment Kit -
YOURx-TAP

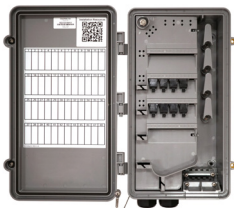

StreetSmart Collector Box



FieldShield Drop Cables



FieldShield Microduct

MDU Small to Mid High Rise - Centralized Split

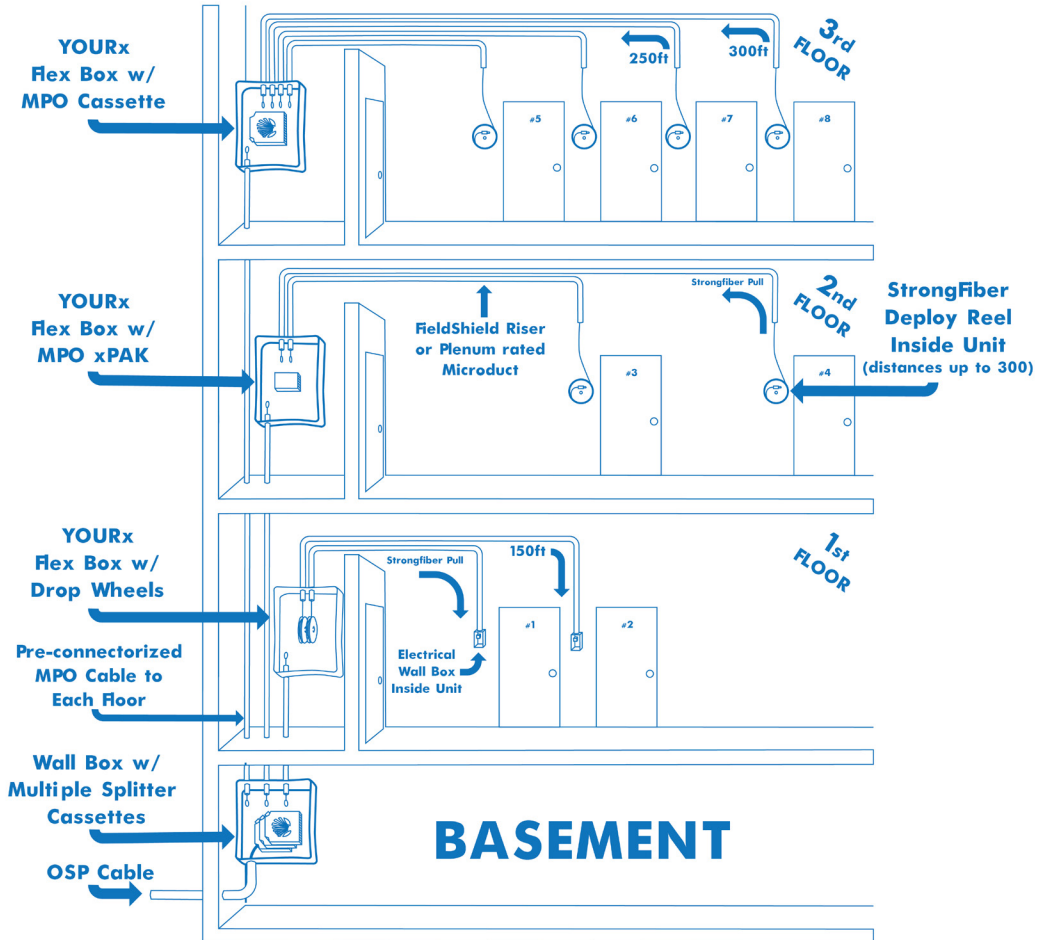

	Product	Description
Box	FDP-XWBF-CPLATE	Empty Flex Box with Combo Plate
	016280	FlexPort for 10mm Duct
Cassette	M9K-PES-CAZ-ZZZ	1x32 Splitter with SC/APC
	4PAK-SCA-MTP	xPAK with MPO and SC/APC (4)
	ENL-012-C1F-SUB	Clearfield Blue Cassette with MPO and SC/APC (12)
Drop Wheel Cradle	DWC-SCA4-MPO	Drop Wheel Cradle with MPO and SC/APC, No Drop Wheels
Drop Wheel	DW-001-SCA-SCA 200F	Drop Wheel with 200 Ft. StrongFiber, SC/APC Pushable
Deploy Reel	SRD-C1SA-DZZC	Deploy Reel with 300 Ft., StrongFiber, SC/APC Pushable
Microduct	FS-DCR-NT-610-PS-2000F	Microduct, 10 mm, Riser Rated, White, 2000 Ft.

Larger MDU High Rise - Plug-and-Play Centralized Split

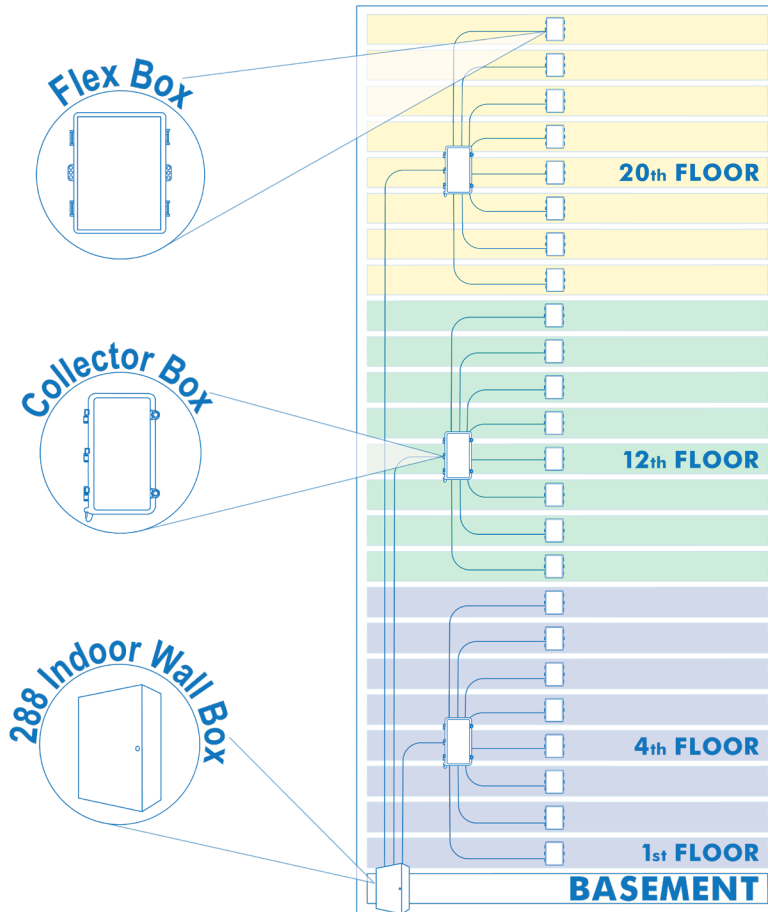

	Product	Description
288 FDP Wall Box	W-BC2-288-C1Z-Z9Z	FieldSmart Indoor Wall Box with splitter and 288 distribution ports
Intermediate Box	W2WC-965-Z2A-ZZZ xxxF	Streetsmart Collector Box with pigtail xxxxF
Floor Box	WQB-012-C1F-HZZ	YOURx Flex Box with cassette and universal plate

MDU Mid Rise - Distributed Split

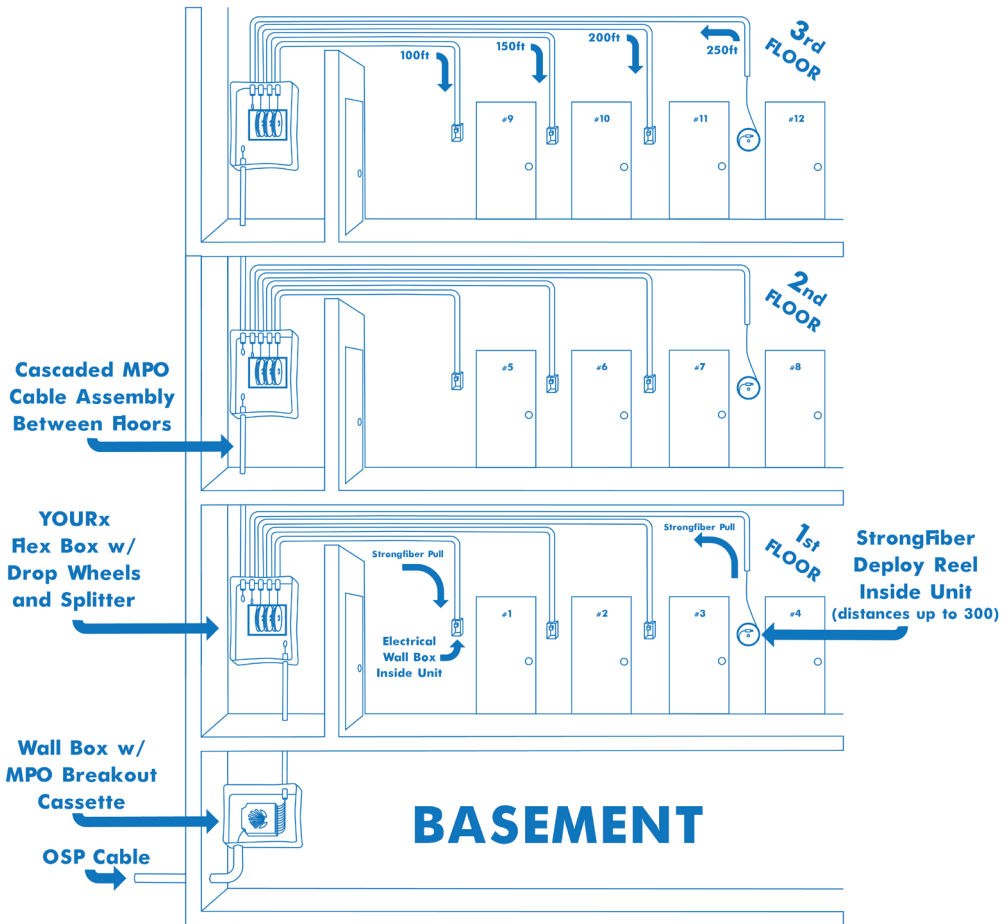

	Product	Description
Box	FDP-XWBF-CPLATE	Empty Flex Box with Combo Plate
	016280	FlexPort for 10mm Duct
Cassette	ENL-012-C1F-SUB	Clearfield Blue Cassette with MPO and SC/APC (12)
Drop Wheel Cradle	DWC-12X-04C-8ZZ	Drop Wheel Cradle with MPO, 1x4 Splitter, SC/APC (4), No Drop Wheels
Drop Wheel	DW-001-SCA-SCA 200F	Drop Wheel with 200 Ft. StrongFiber, SC/APC Pushable
Deploy Reel	SRD-C1SA-DZZC	Deploy Reel with 300 Ft., StrongFiber, SC/APC Pushable
Microduct	FS-DCR-NT-610-PS-2000F	Microduct, 10 mm, Riser Rated, White, 2000 Ft.

MDU Small to Mid Rise - Building Wrap

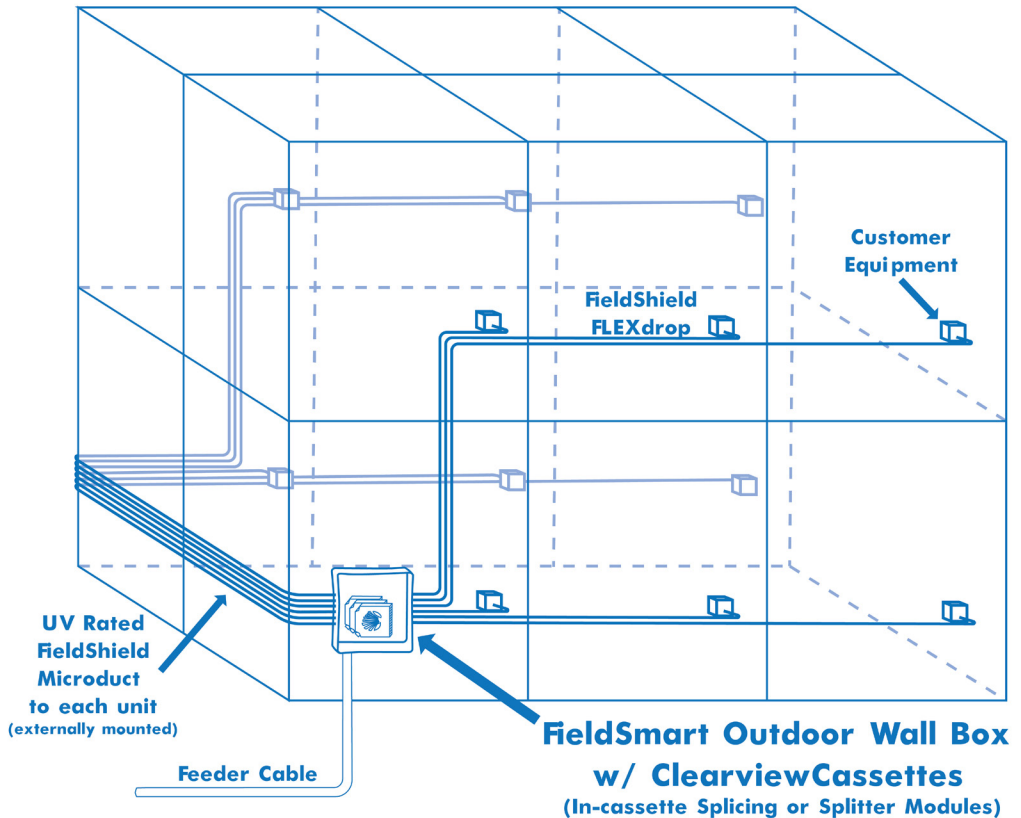

	Product	Description
Box	FDP-XWBF-CPLATE	Empty Flex Box with Combo Plate
	016280	FlexPort for 10mm Duct
Cassette	EPZ-012-C1F-SUB	Patch and Splice Cassette, Loose Tube with 12 SC/APC
	EPZ-012-C2F-SUB	Patch and Splice Cassette, Ribbon with 12 SC/APC
Deploy Reel	FDR-C1FA-DZZ2	FLEXdrop Deploy Reel with Pushable SC/APC 50' Length
	FDR-C1FA-DZZ4	FLEXdrop Deploy Reel with Pushable SC/APC 100' Length
Microduct	FS-MED-NT-810-2000F	Microduct 10mm, Non-toneable, Black, 2000F

MDU - Townhouse

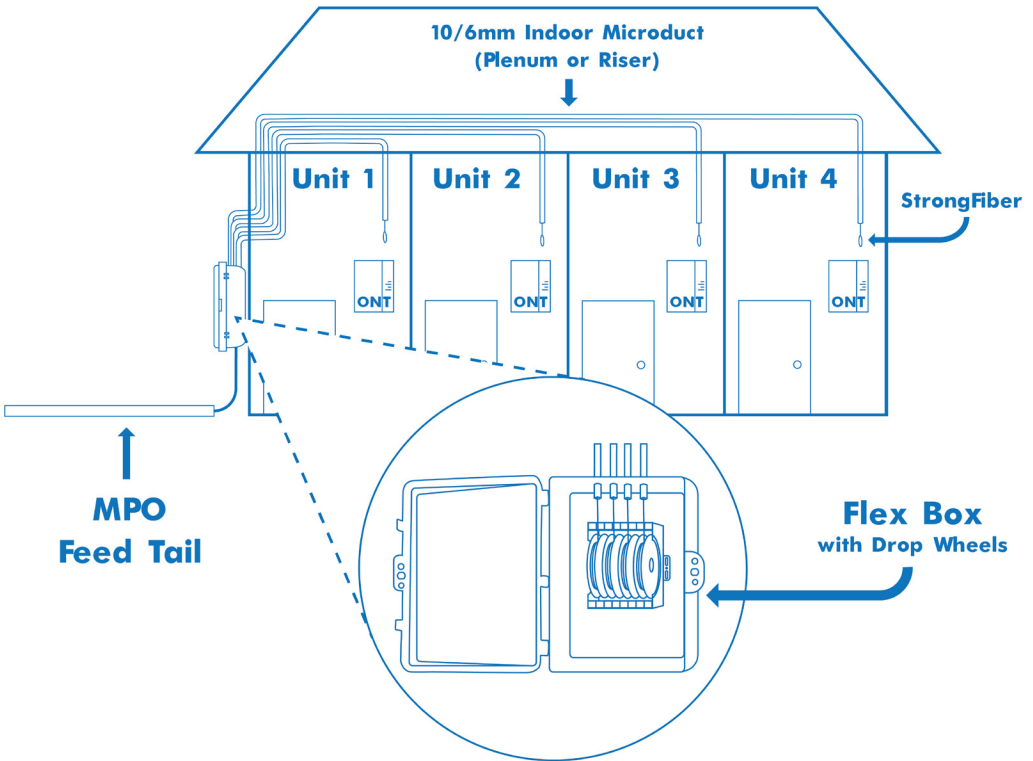

	Product	Description
Box	FDP-XWBF-CPLATE	Empty Flex Box with Combo Plate
	016280	FlexPort for 10mm Duct
Drop Wheel Cradle	DWC-SCA4-MPO	Drop Wheel Cradle with MPO and SC/APC
Drop Wheel	DW-001-SCA-SCA 200F	Drop Wheel with 200 Ft. StrongFiber SC/APC Pushable
Microduct	FS-MED-NT-810-2000F	Microduct 10mm, Non-toneable, Black, 2000F

MDU - Garden Style/Condo

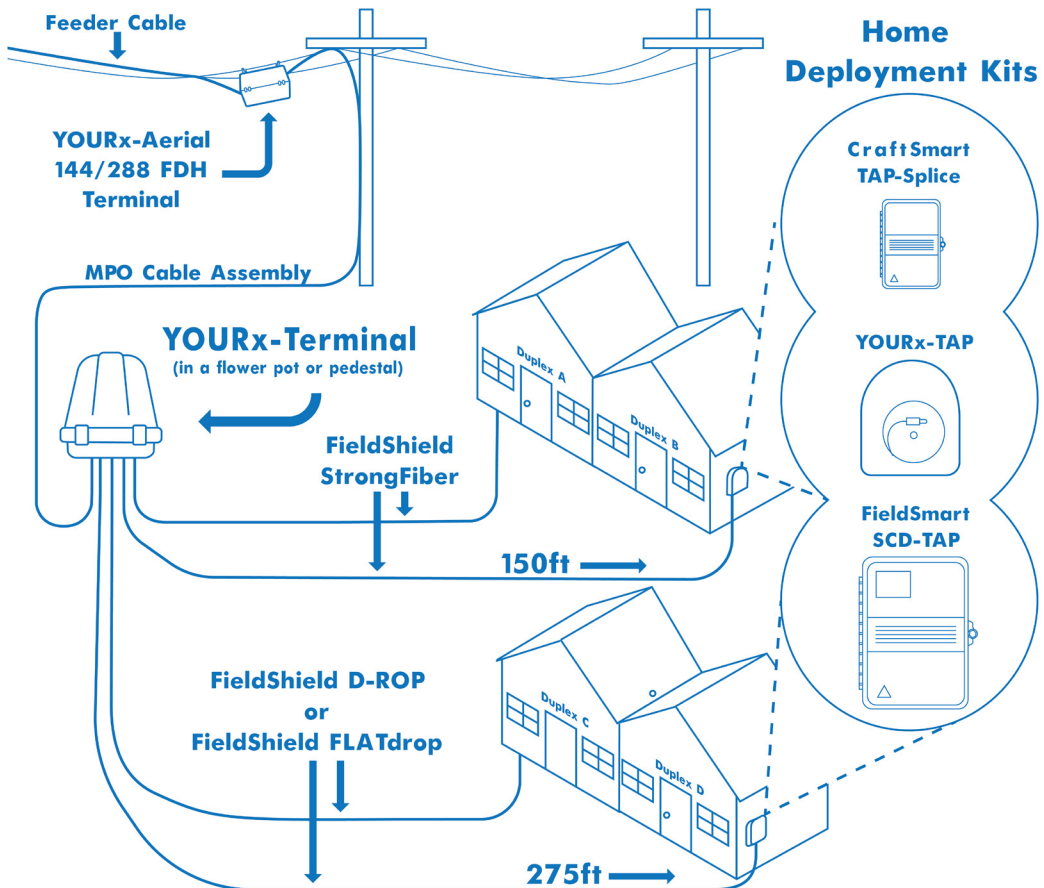

	Product	Description
Aerial	AFT-245-Z1F-Z1Z-01	Aerial Terminal with MPO drops
Terminal	FSTX-04C-51Z-ZAZ	Terminal with MPO Input and 4 SC/APC Drops
HDK	HDK-AACC-CDF3-CCFW1	TAP, FLEXdrop Entrance Fiber and Slack Reel, FLEXdrop Equipment Fiber and Fiber Outlet Box
	HDK-DACC-CDD6-CCFW1	FieldSmart SCD TAP Box, FLEXdrop (Black) Deploy Reel Loaded With SC/APC Adapter and Std. Simplex SC/APC to Pushable SC/APC 100'
Microduct	FS-MEO-T-210-2000F	Microduct, Toneable, Orange, Direct Bury, 2,000 Foot Spool
Deploy Reel	SRD-C15A-DZZ8	StrongFiber Deploy Reel, SC/APC, 200 Feet
FLATdrop	FSH-U1-001-CQK-D3K 0300F	FieldShield FLATdrop Peelable 3MM Patchcord, Singlemode, 1 Fiber, Toneable Flat Cable, SC/APC YOURx 3MM Breakout to SC/APC Pushable

MTU High Rise - Mid Span and Centralized Split

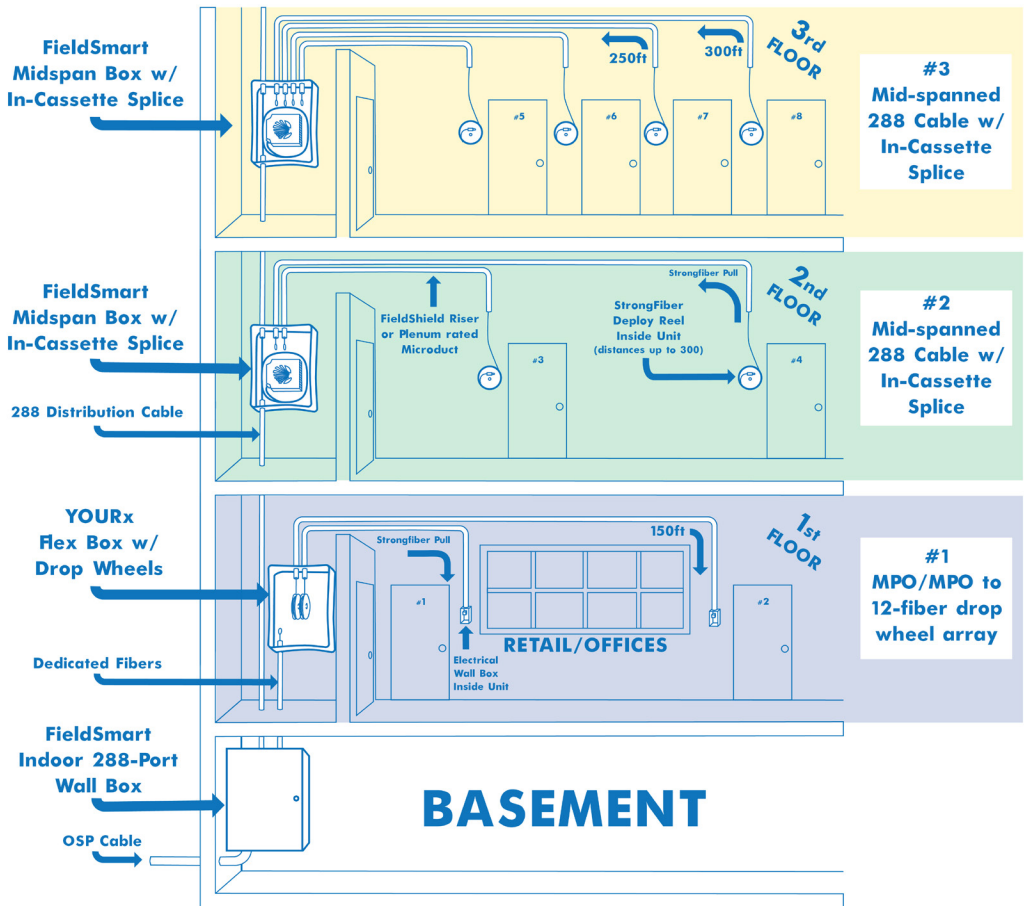

	Product	Description
288 FDP Wall Box	W-BC2-288-C1Z-Z9Z	Fieldsmart Indoor wall box with splitter and 288 distribution ports
Business Box	WQM-002-C1S-CZZ 200F	YOURx Flex box with MPO drop wheel cradle and two drop wheels
Floor Box	FDPM-XWB2-12-SCA-B	Fieldsmart Mid Span Wall Box loaded with cassette
Microduct	FS-MCP-NT-610-2000F	Microduct 10mm, Riser, White, 2000F

MTU - 288 Feeding Multi-Fiber Complex

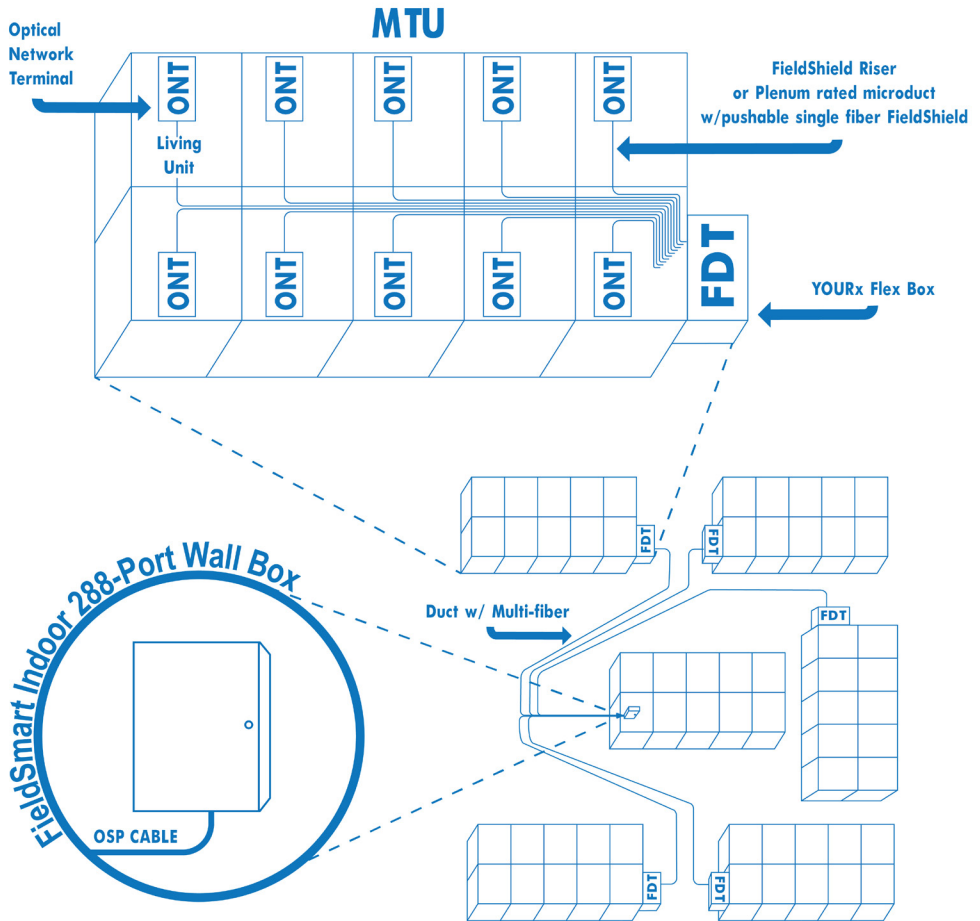

	Product	Description
288 FDP Wall Box	WB288-CFWM	FieldSmart Fiber Delivery Point Wall Box, 288 Max. Cap., Indoor Rated
Splitter	KE1-CAA	WaveSmart HD 1x32 Splitter SC/APC
Cassette	E3R-012-C1F-SUB	Clearview Black Cassette, MPO to 12 SCAPC
MTU-Box	FDP-xWBF-CPLATE	Empty Flex Box with Combo Plate
Drop Wheel cradle	DWC-SCA8-MPO	Drop Wheel Cradle with MPO and SC/APC
Drop Wheel	DW-001-SCA-SCA 200F	Drop Wheel with 200 Ft. StrongFiber SC/APC Pushable
Microduct	FS-MCP-NT-610-2000F	Microduct 10mm, Riser, White, 2000F



CLEARFIELD

Learn more at www.SeeClearfield.com

P: 800.422.2537

F: 763.475.8457

Clearfield, Inc. (NASDAQ: CLFD) designs, manufactures and distributes fiber optic management, protection and delivery products for communications networks. Our “fiber to anywhere” platform serves the unique requirements of leading incumbent local exchange carriers (traditional carriers), competitive local exchange carriers (alternative carriers), and MSO/cable TV companies, while also catering to the broadband needs of the utility/municipality, enterprise, data center and military markets. Headquartered in Minneapolis, MN, Clearfield deploys more than a million fiber ports each year.

July 2021