

Clearview Cassette xPAK

Installation Manual

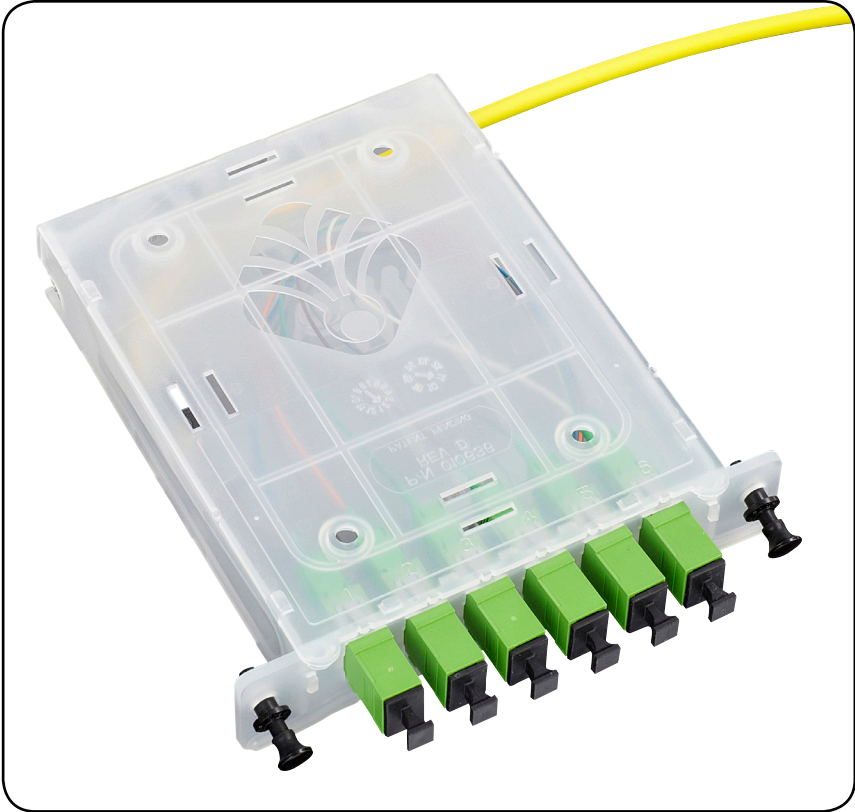

Clearview Cassette xPAK

Installation Manual



Table of Contents

Application	3
Description	3
Technical Specifications	3
Configurations	4
Parts List	6
Splicing in the xPAK	7
U-Mount	17
Connector Cleaning Procedure	18
Standard Warranty	21
Proprietary Notice	22
Technical Support	22



Clearview Cassette xPAK

Installation Manual

Application

Engineered to land small port count fiber assemblies and optical components as conveniently and inexpensively as possible, the xPAK simplifies fiber management to the level of a consumable good. Clearview xPAK can be deployed as a stand-alone device, or with FieldSmart® Fiber Deliver Point (FDP) products for a wide range of network environments.

Description

At first glance, Clearview xPAK looks like any other LGX compatible package, but upon closer inspection, technicians will see a new generation of innovation in the delivery of terminated fiber assemblies. Clearview xPAK is single-piece element in which all required components for fiber protection are integrated. It is shipped flat and simply folds to shape.



The Clearview xPAK supports two, four or six ports of patch and splice configurations. The compact 4" x 5" solution is perfect for landing small count terminations at the fiber delivery point. The kit comes with everything you'll need: flat cassette, adapters, 1, 2, 4 or 6-fiber 900 μ m ½ meter assembly, splice sleeves, strain relief boot, grommet tape, zip ties and universal mounting bracket.

Priced to allow field personnel to carry quantities of Clearview xPAK Cassettes in the field, xPAK is shipped flat and unassembled. At the deployment site, the technician will take the xPAK device, and following pictorial user instructions, will assemble the device to match his field requirements. Integrated into the footprint of the device, is an industry-compatible splicing tray, which is then surrounded with fiber protection elements that support either a two, four or six port fiber assembly as well as a range of optical component devices.

Clearview xPAK is the ideal fiber management device when up to six fibers are landed or an optical component device is deployed in a remote location. Application environments include cell backhaul, business class service delivery, node segmentation, fiber exhaust in a field pedestal, sub-station turn-up or fiber-to-the-desk deployment.

Technical Specifications

Clearview xPAK	
Dimension	1.14" H x 4" W x 5.38" D
Ratings	Terminations are designed and tested to Telcordia GR-326; Clearfield® FiberDeep® Guarantee: 0.2 dB insertion loss or less, exceeding industry standards
Backwards Compatible	N/A
Material	Durable polypropylene (impact plastic)
Connector Types	Supports industry standard SC, LC, ST, FC and MPO singlemode and multimode connectors
Meters/Feet of Slack Storage	½ meter of 900 μ m tight buffer fiber used for internal splicing, 12-fiber xPAK requires ribbon splicing
Mounting Options	Standard faceplate and LGX faceplate

Clearview Cassette xPAK

Installation Manual



Configurations

Patch and Splice

The 6-fiber splice tray molded into the xPAK tray is all that is needed to deliver an integrated patch and splice application. 2, 4 or 6-fiber 900 μm $\frac{1}{2}$ meter assemblies are pre-terminated, pre-loaded and slack stored inside the xPAK ready for splicing.

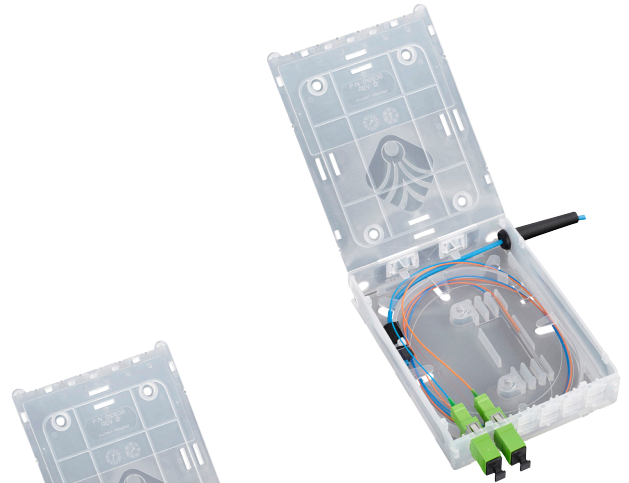

Patch Only

Regardless of the industry standard adapter or cable construction, the pre-terminated length of OSP or IFC cable is pre-loaded within Clearview xPAK for patch only configurations.

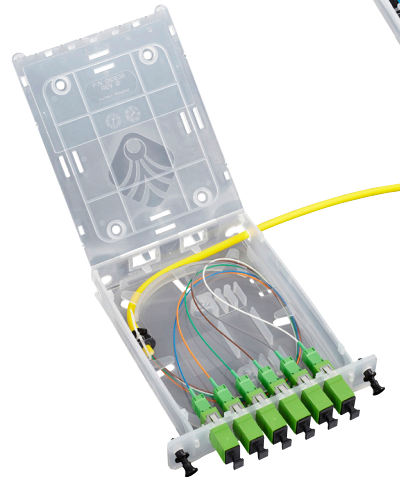

Optical Components

Optical components can be integrated into the Clearview xPAK. Options include circulators, WDM and splitters from 1x2 to 1x6.



Plug-and-Play

MPO to 12-fiber 900 μm assembly allows for plug-and-play by mating MPO to MPO with pre-terminated multi-fiber OSP or IFC. Optional faceplate allows for a max of 8 SC connections.

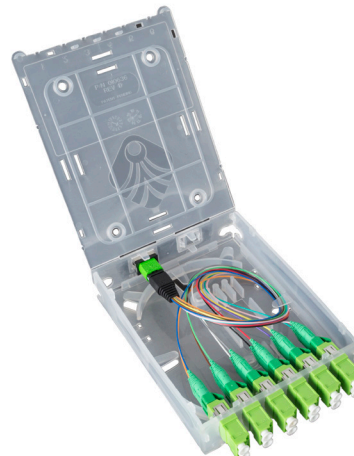





Parts List

Clearview Cassette xPAK

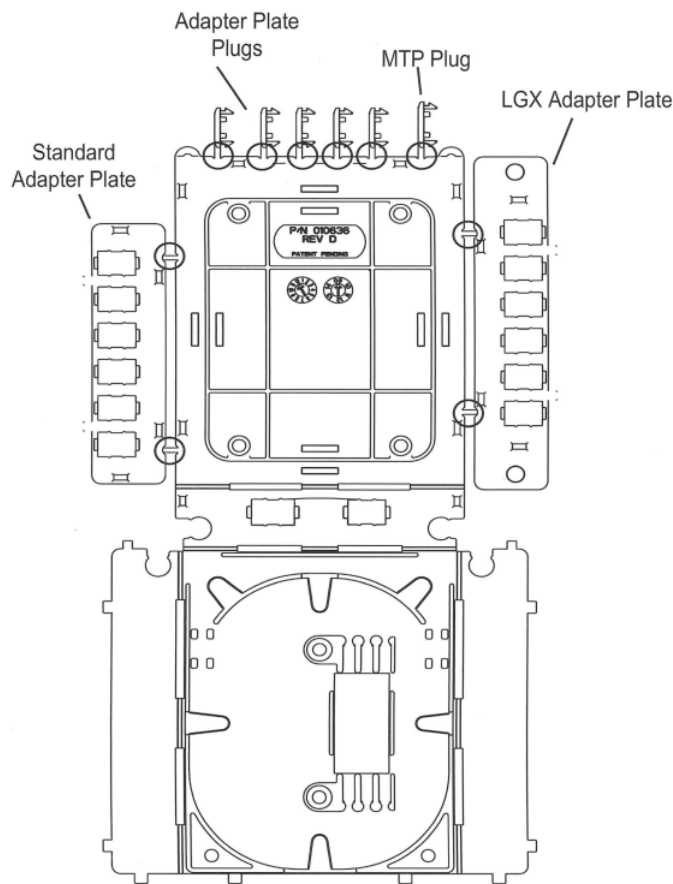
Installation Manual



○ = Cut Points

 Splice Sleeve x 2, 4 or 6

 Zip Tie x 1

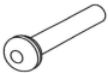
 Strain Relief Grommet x 1

 Push/Pull Plunger x 2

 Push/Pull Grommet x 2

 Cable Retainer x 4

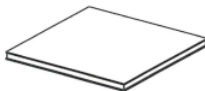
 Velcro x 1

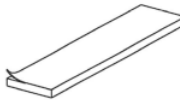
 Grommet Tape x 1

 SC Adapter x 2, 4 or 6

OR

 LC Duplex Adapter 1, 2 or 3

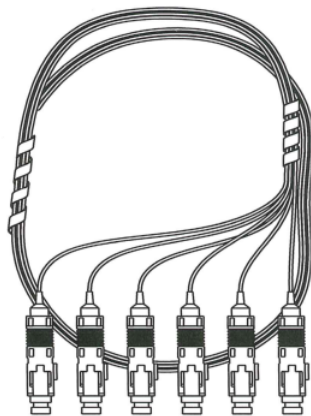

Cable Assembly

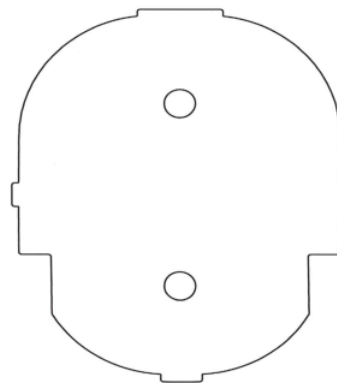

Splice Tray Cover x 1

Clearview Cassette xPAK

Installation Manual



Splicing in the xPAK

Remove the xPAK from its packaging. Unwrap the white twist ties around the 900 micron fibers and save them for later in the process.

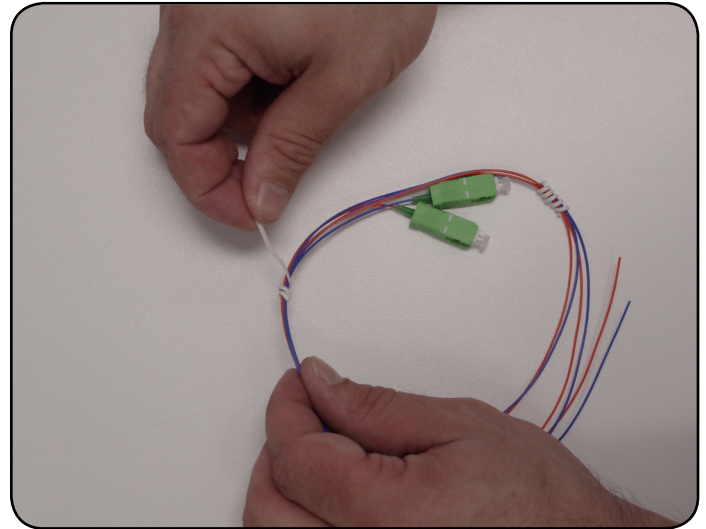

With a side cutters, snips, or sharp knife, carefully cut the two adapter plates and 6 adapter plate plugs from the plastic molded xPAK. Be sure to trim off any tabs or excess molded material from all parts.

Note: Do not discard these pieces, as some or all will be used later in the process.

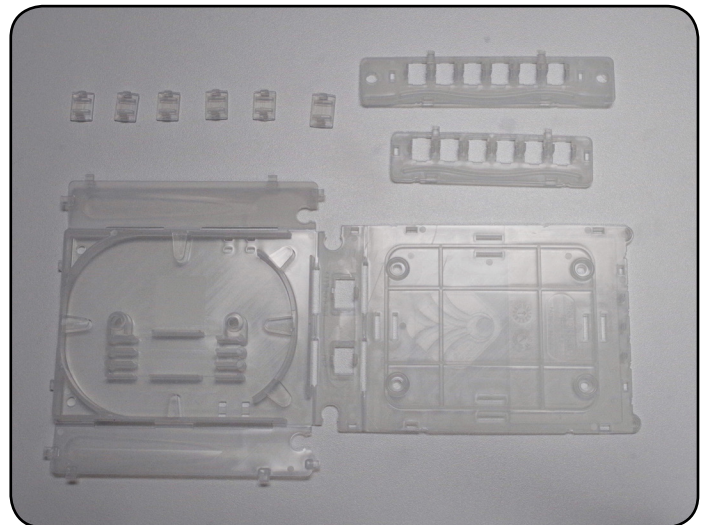
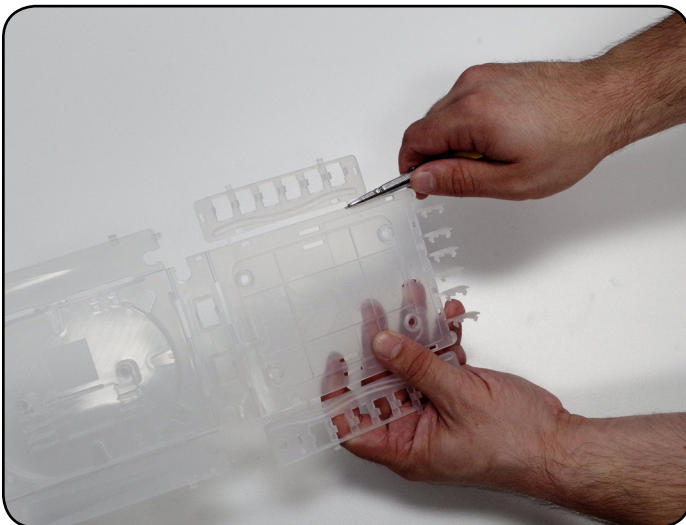
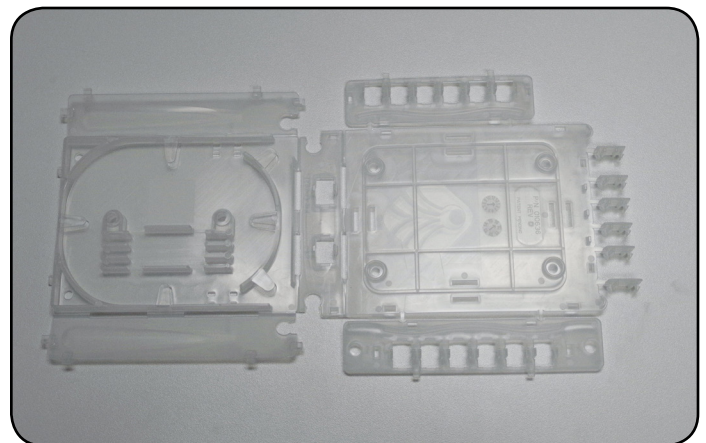

Slide the fiber through the strain relief boot, and push the boot over 3ft (1m) down the fiber.

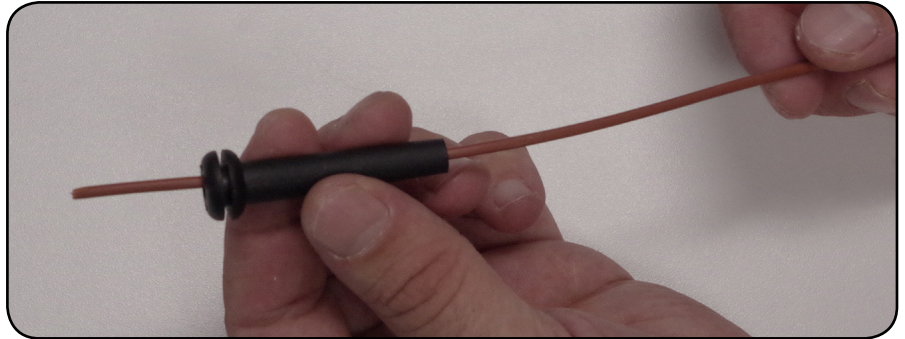

Fold the back portion and one of the side walls of the xPAK up, and snap them together.

Note: If you are using the strain relief boot, install it in the opening before snapping the back and side walls together.

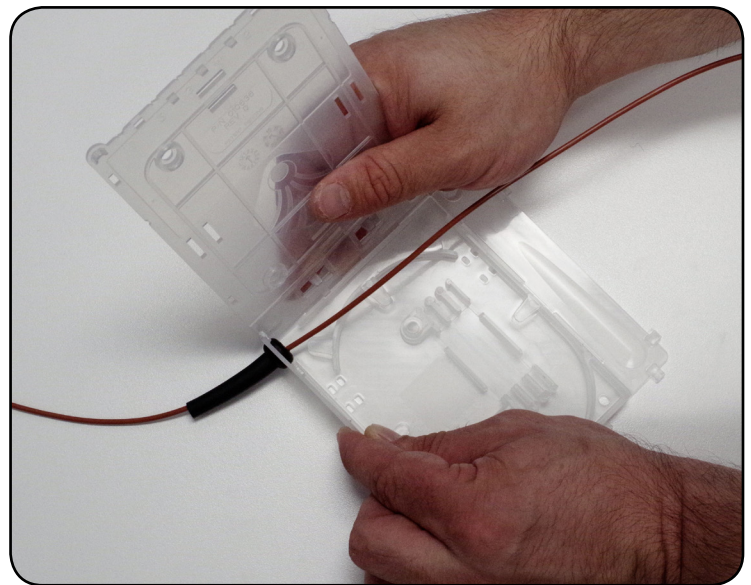

Snap the opposite side wall and back together.

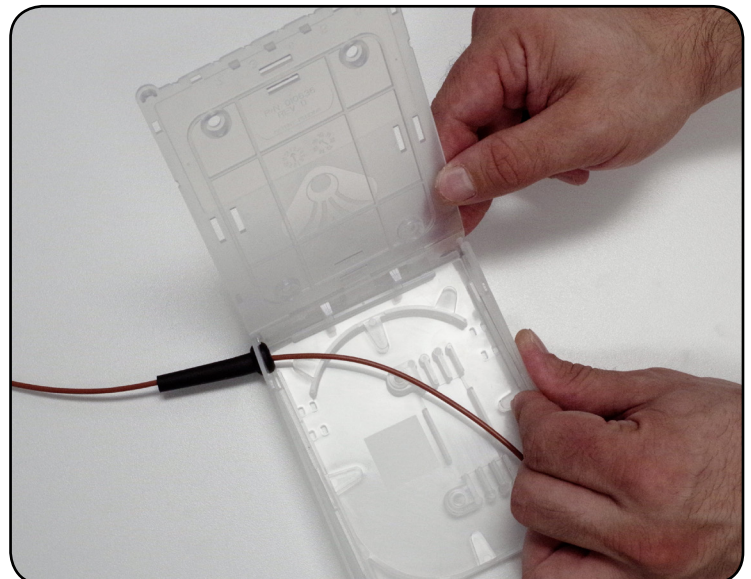

Clearview Cassette xPAK

Installation Manual



Mark the buffer tube with a permanent marker 3ft back from the end.

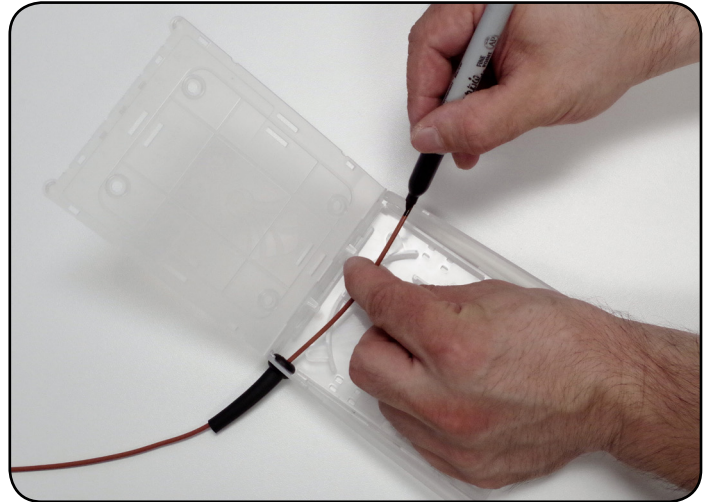

Wrap one lap of grommet tape around the buffer tube and trim the excess.

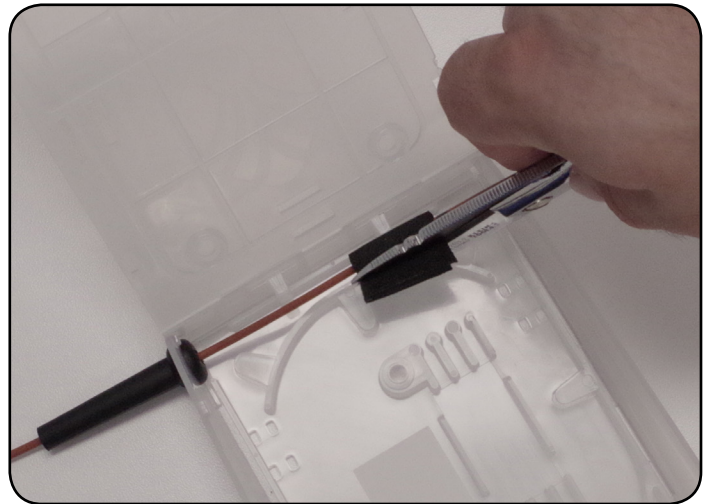

Open up the buffer tube after the grommet tape, exposing the fibers.

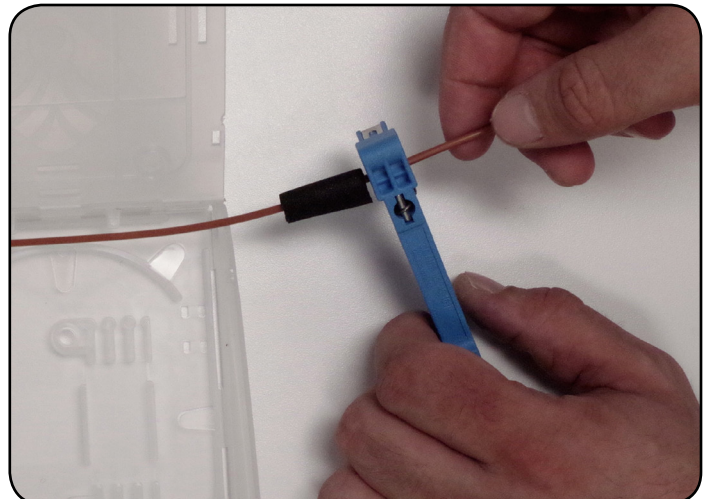

Route the buffer tube under around the outer track and under the fiber management tab, then secure the buffer tube into place using the provided zip tie.

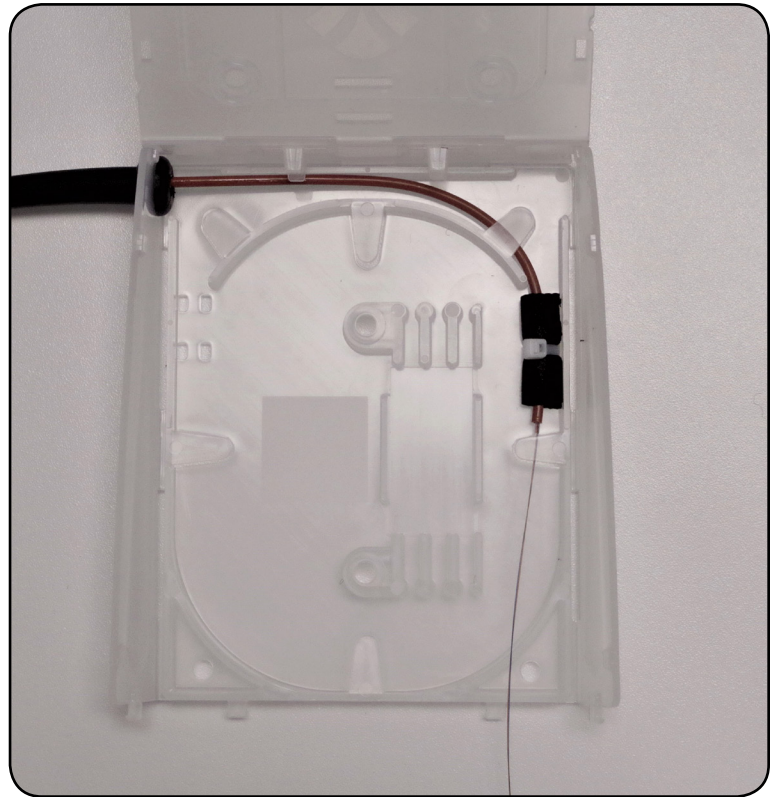

Route the fibers 1 ½ turns around the inside track and into the splicing area, then trim to length.

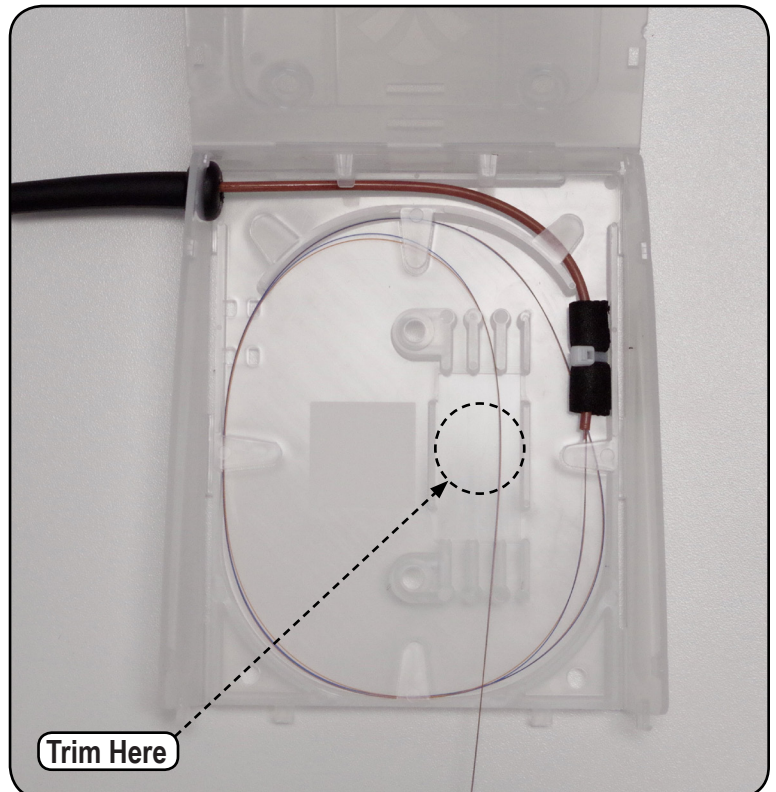

Clearview Cassette xPAK

Installation Manual



Install the adapters in the correct adapter plate (Either standard or LGX plate). Plug the cable assembly into the back of the adapters.

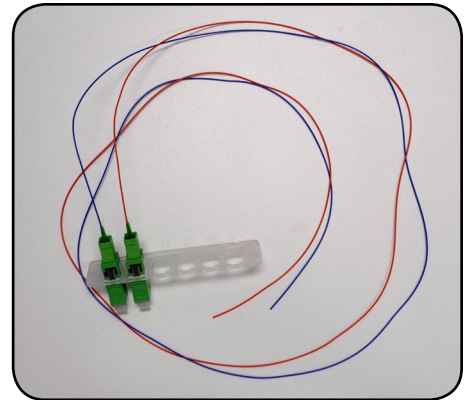
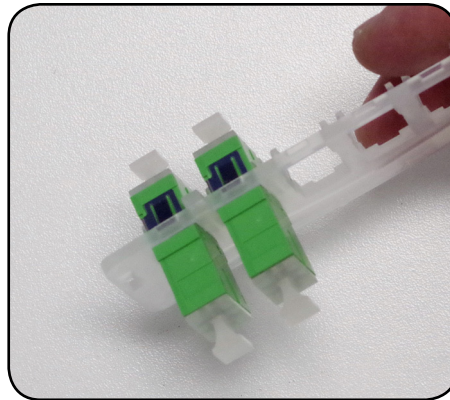
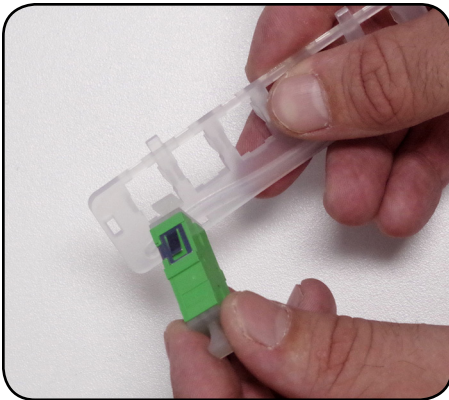

Temporarily install the faceplate onto the xPAK.

Route the 900 micron fibers 1 ½ turns in the opposite direction of your incoming fibers and into the splicing area to estimate the length for proper storage.

Trim to length at the center of the splicing area.

Remove the faceplate and cable assembly.

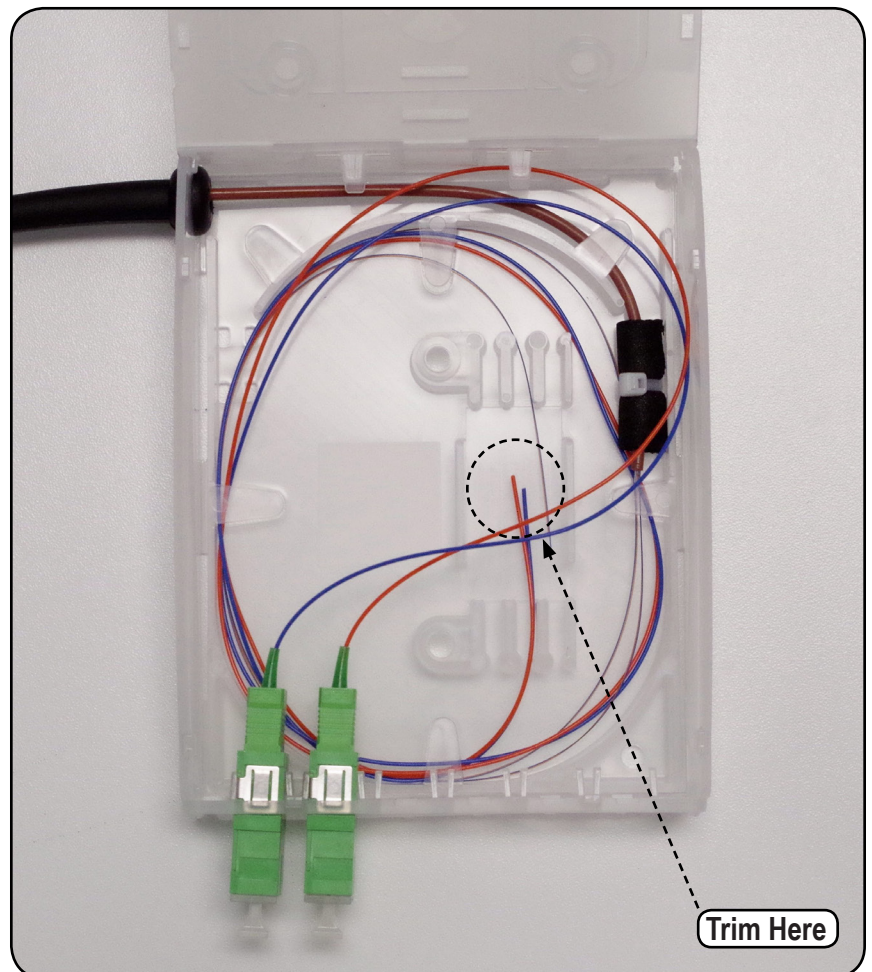

Slide the provided splice sleeves over the fibers to be spliced, and proceed to splicing the fibers.

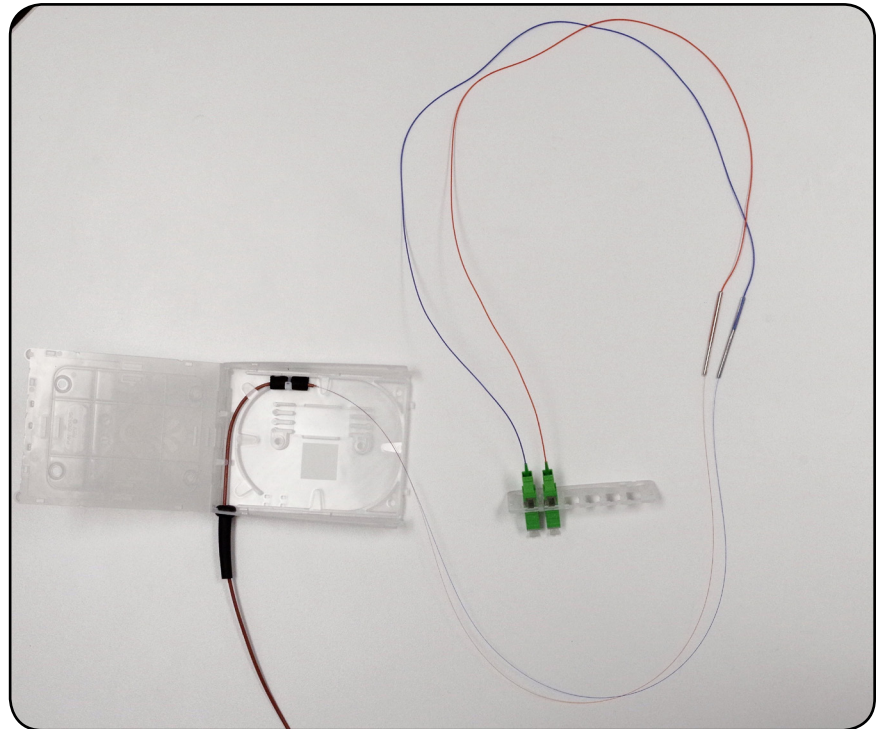

Route the incoming fibers in the bottom area of the splice tray

Note: Secure the splice sleeves in the splice tray using silicone sealant.

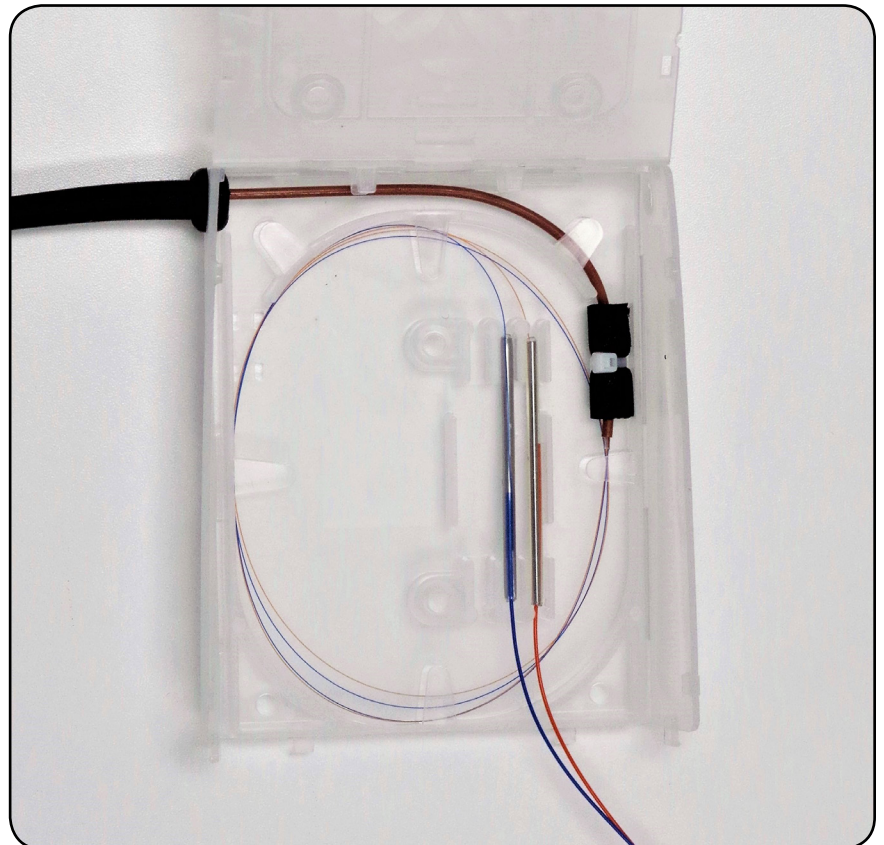

Clearview Cassette xPAK

Installation Manual



Bring the fibers around halfway and direct them towards the back corner and out of the xPAK, allowing them to sit in the cut out of the splice tray cover when it is installed.

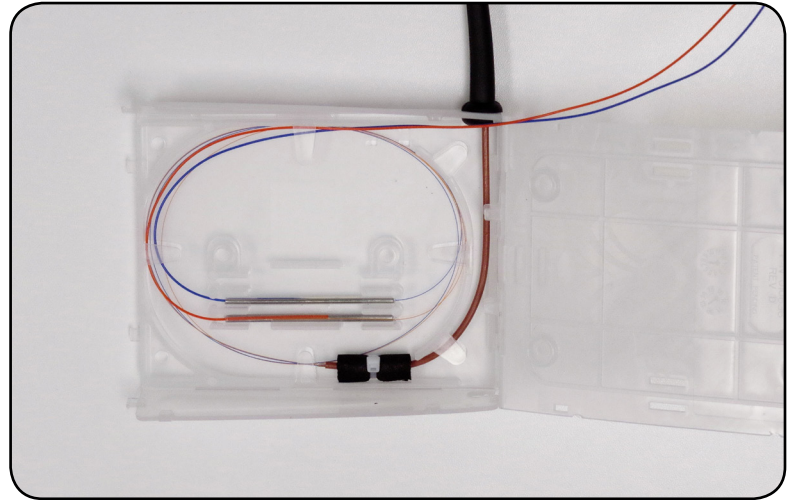

Install the splice tray cover, transitioning the 900 micron fibers through the cut out and onto the top of the splice tray cover.

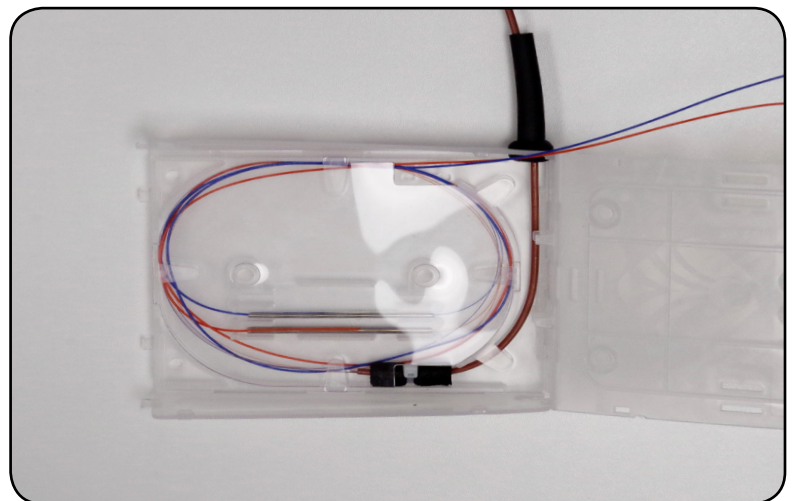

Install your faceplate onto the xPAK and dress the fibers on top of the splice tray cover with the white twist ties originally supplied on the fiber assemblies.

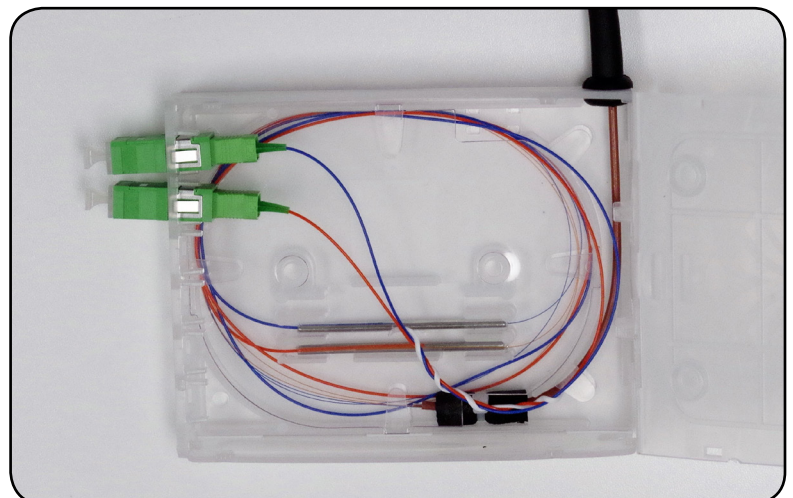

Snap the top cover into place on the xPAK.

Note: There are 6 snap points - make sure all are snapped correctly.

If the LGX adapter plate is used, install the push/pull grommet and plungers into the holes on the sides of the faceplate.

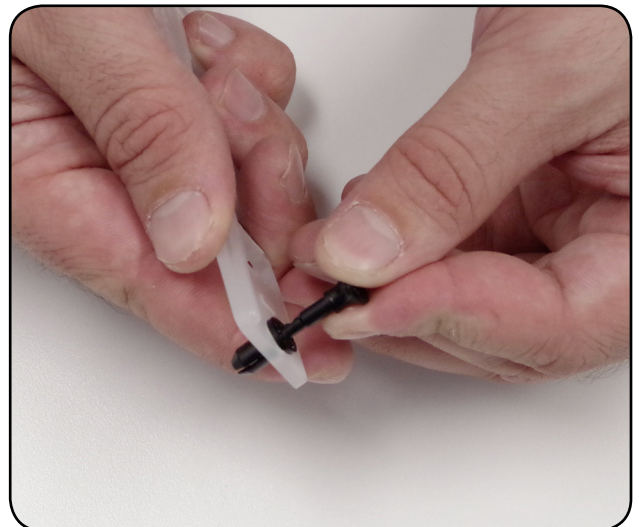
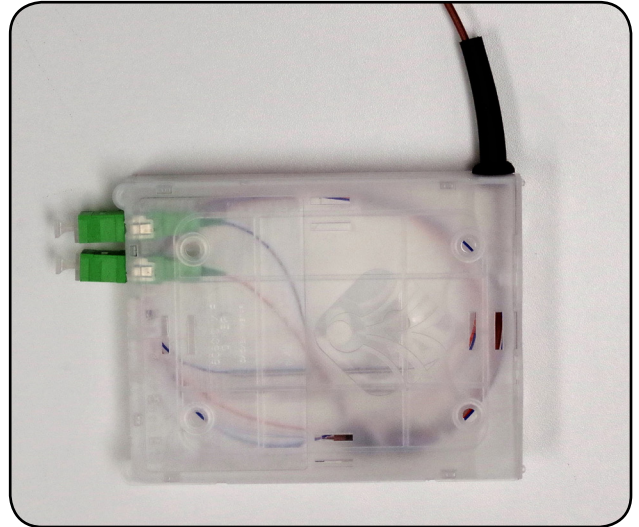

Clearview Cassette xPAK

Installation Manual



Snap the adapter plate plugs in to any of the open adapter ports (both front and rear of xPAK).

Note: One of the plugs is a larger size, meant to plug the MPO adapter location on the back of the xPAK.

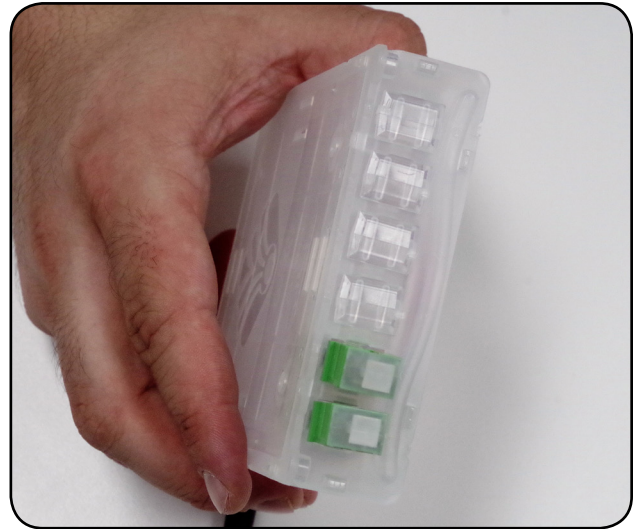

Optional slack storage clips can be added to the xPAK by plugging them into the four holes on the top cover.

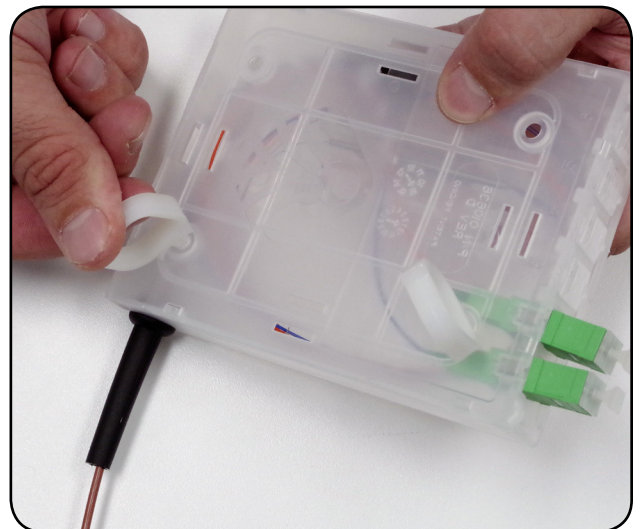

Mounting the xPAK can be done with the double sided 2" x 2" Velcro patch provided or by using the two retaining plugs that snap into the U-Mount bracket that is included with each xPAK.

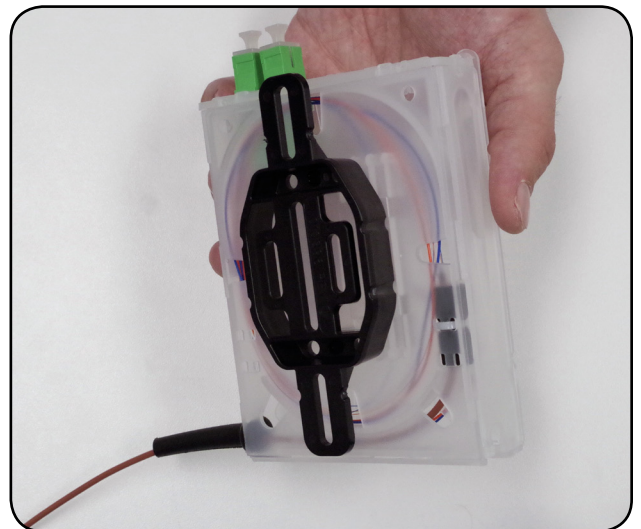

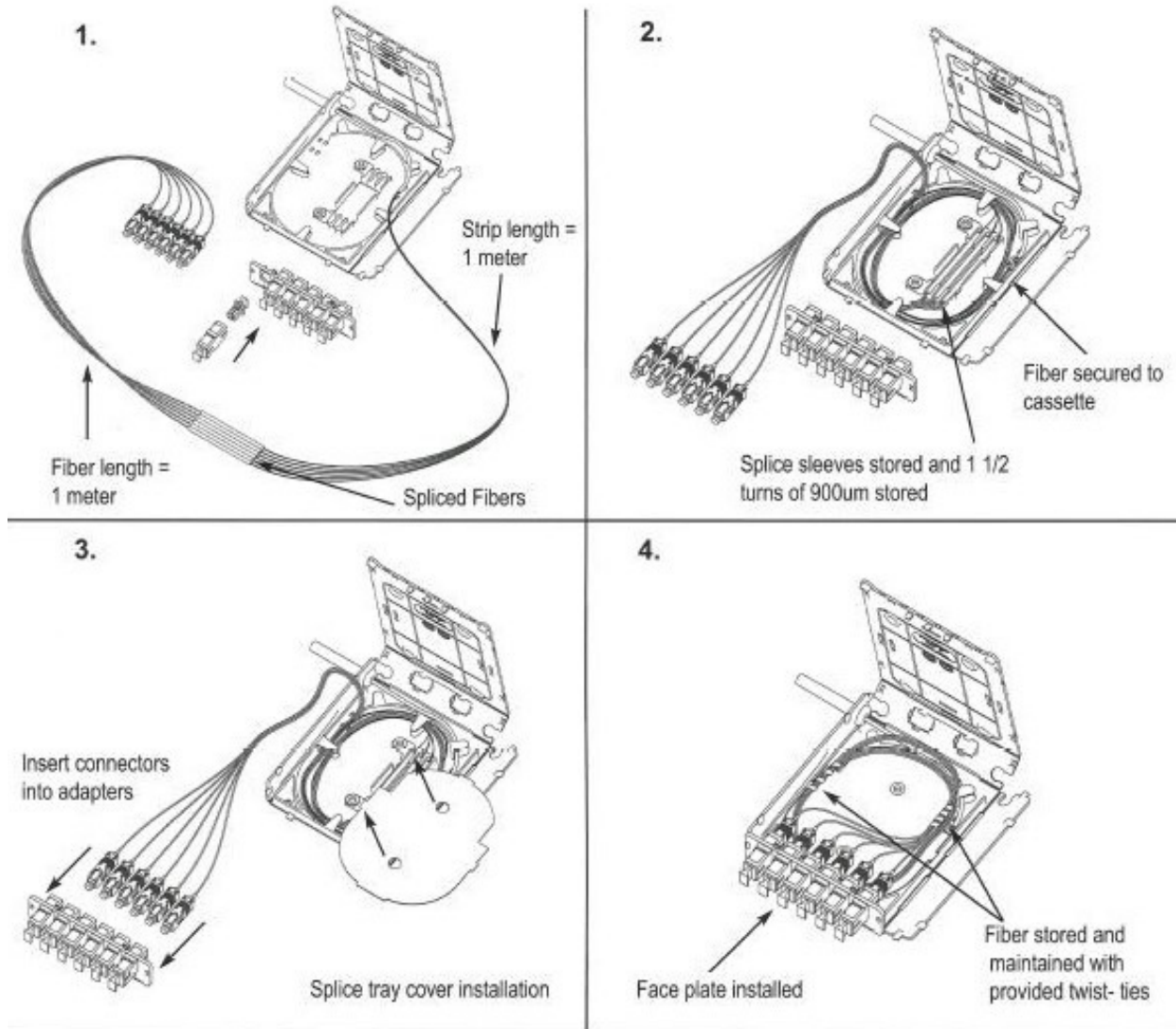

Option: Slack Storage

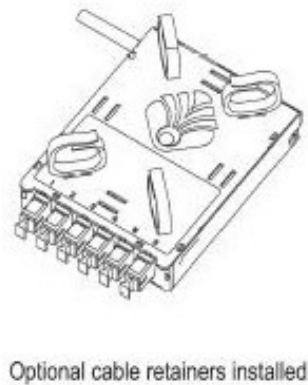

Option: LGX

If using a LGX plate...

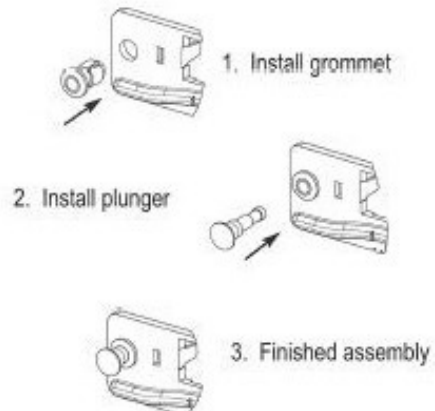

Clearview Cassette xPAK

Installation Manual



U-Mount

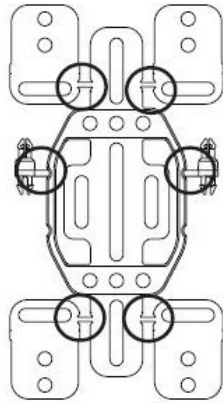

Cut at circles.

xPAK Cassette snaps into place with provided holes.

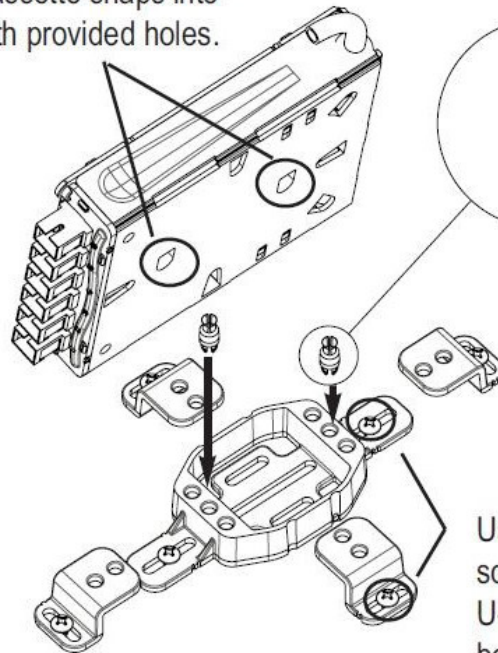

Trim flush and install into base of U-Mount as shown.

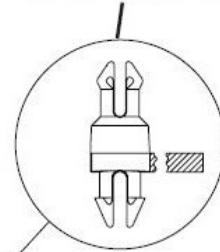

Use provided screws to attach U-Mount to back board.

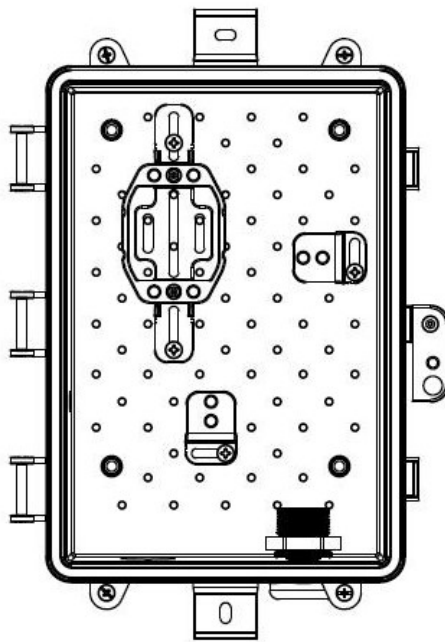

U-Mount installed in Clearfield Wall Box

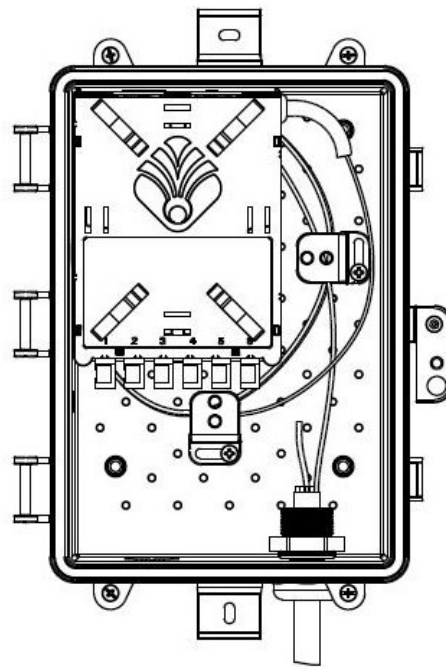

xPAK attached and buffer tube slack stored below xPAK in U-Mount clips.

Connector Cleaning Procedure

Whether factory terminated or field spliced, clean connectors are essential for proper system operation. Even the smallest dust particle can cause transmission problems, so for optimal network performance, inspect and if necessary, clean all connectors and adapters prior to mating.

I.B.Y.C...Inspect Before You Connect!

ALWAYS inspect the connector first thing with a clean fiber scope inspect the pair. Three types of contamination require different cleaning techniques. The use of Chemtronics end face and bulkhead cleaning products and techniques ensures a clean end face, no matter the type of contamination.

These are Clearfield recommended products/application. Use the product you feel will complete your cleaning procedures. Create a "best practice" for your company and follow those procedures.

****NOTE: It is NOT recommended to use IPA to clean the end-face.**

Cleaning the end-face...but not just the end-face

- Place one wiping paper on QbE-2 FiberSafe™ Cleaning Platen. **Figure 1**
- Apply small amount of precision cleaner (about 1" in diameter) with Electro-Wash MX pen on to one end of the wipe. **Figure 2**
- Hold end face 90 degree. Adjust for APC connection by slightly tilting the container or end face. Angle is correct when no drag is left on the end face. **Figure 3**
- Draw end face from wet to dry part of the wipe 3 times. Use just enough pressure to ensure complete contact between end face and the wipe.

DO NOT retrace previous step.



Figure 1



Figure 2



Figure 3

Clearview Cassette xPAK

Installation Manual



- **CLEAN THE FERRULE...**Lightly moisten the fiber optic swab (2.5mm/38542F or 1.25mm/38040) by spotting a small amount (about 1") of Electro-Wash PX or Electro-Wash MX pen onto the QBE-2. Hold the swab, 1 side down to the wetted area and hold for a count of 1-2-3-4-5.

Figure 4

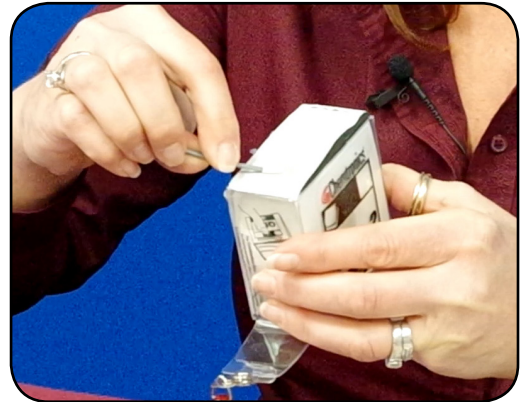

Figure 4

- Insert swab into side of ferrule, wet side to the ceramic ferrule and circle around 2-3 times and remove. Turn swab to dry side and repeat.

Figure 5

Cleaning the mate through a bulkhead adapter AND the adapter itself!

- Lightly moisten the fiber optic swab(2.5mm/38542F or 1.25mm/38040) by spotting a small amount (about 1") of Electro-Wash PX or Electro-Wash MX pen onto the QBE-2. Hold the tip of the swab onto the wetted area and hold for a count of 1-2-3-4-5.

- Insert the swab into the adapter to the connector, press lightly against the connector, twist 2-3 times, remove and discard.

- Dry with a second dry swab.

- Inspect (re-clean if necessary) and test for signal strength.

- Use additional swabs to clean inside the actual adapter. Moisten swab, like above, insert through hole and remove while twisting. **Figure 6**



Figure 5

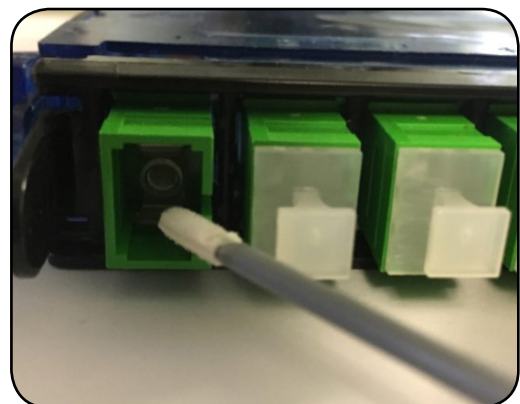

Figure 6

Cleaning an MPO/MTP Connector

Female Connector

- Place one wiping paper on QbE-2 FiberSafe™ Cleaning Platen and apply small amount of precision cleaner (about 1” in diameter) with Electro-Wash MX pen on to one end of the wipe. **Figure 1**
- Hold end face 90 degree. Adjust for APC connection by slightly tilting the container or end face. Angle is correct when no drag is left on the end face. **Figure 2**



Figure 1

Male Connector

- Lightly moisten the fiber optic swab (CC505F) like above, moistening 1 side.
- Place swab, wet side down at one end of connector end-face and draw across in a diagonal sweep (ie: from fiber 1 up and across to fiber 12). Turn swab over to dry and draw back from fiber 12 to fiber 1. **Figure 3**

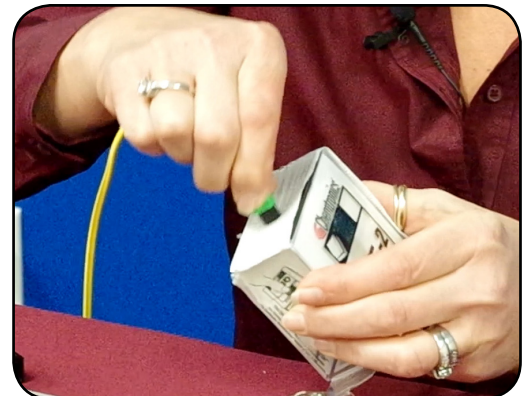

Figure 2



Figure 3

BEFORE cleaning any connector...be sure you know what type of contaminate you are cleaning...dry? Fluidic?...All the available products are good, it's the process that you need to be aware of. Using a dry cleaning method to clean "dirt" can lead to scratching of the end-face. Learn the process of cleaning properly!

Standard Warranty

Clearfield warrants to the original purchaser of the Product sold hereunder is free from defects in material and workmanship under normal use and service, subject to exceptions stated herein. Product purchased is warranted as follows: Clearfield designed and branded Products are warranted for three (3) years; Products manufactured by Clearfield to customer prints and/or specifications are warranted for one (1) year; and any Product Clearfield acquires from or through a third-party manufacturer or distributor and resells to Customer as the original customer will carry the manufacturer's pass-through warranty, if any. In all cases, the warranty period commences on the date of shipment to the original purchaser.

Warranty Claim Procedure

If any Product purchased from Clearfield is found defective under the above warranty, the following basic procedure must be followed:

1. Customer must contact Clearfield and obtain a Return Materials Authorization
2. Following authorization, the Customer ships the product-freight collect to Clearfield's manufacturing facility
3. Clearfield shall repair or replace the defective Product at its sole option and discretion, and return the repaired or replacement Product to Customer's site, freight prepaid

Note: If the Product is not found to be defective at Clearfield, the product will be returned to the Customer and the customer billed for freight in both directions.

View our warranty policy here: <https://www.seeclearfield.com/warranty.html>

Limitations of Warranty

Correction of defects by repair or replacement, at the option of Clearfield Inc, shall constitute the exclusive sole remedy for a breach of this limited warranty. Clearfield shall not be liable under any circumstances for any special, consequential, incidental, punitive, or exemplary damages arising out of or in any way connected with the product or with agreement to sell product to buyer, including, but not limited to damages for lost profits, loss of use, or for any damages or sums paid by buyer to third parties. The foregoing limitation of liability shall apply whether the claim is based upon principles of contract, warranty, negligence or other tort, breach of statutory duty, principles of indemnity or contribution, the failure of any limited or exclusive remedy to achieve its essential purpose, or otherwise.

Clearfield will not be responsible for any labor or materials costs associated with installation or incorporation of Clearfield products at customer sites, including any costs of alteration, replacement or defective product, or any field repairs.

Other Limitations

Clearfield assumes no warranty liability regarding defects caused by:

1. Customer's modification of Product, excepting installation activities described in Clearfield documentation
2. Customer re-packaging of Product for shipment to third parties or destinations other than those originally shipped to by Clearfield, or any defects suffered during shipping where the Product has been re-packaged
3. Customer's installation or maintenance, excepting activities described in and performed in accordance with Clearfield documentation
4. Customer's improper or negligent use or application of Product
5. Other causes external to the Product, including but not limited to accidents, catastrophe, acts of God, government action, war, riot, strikes, civil commotion, sovereign conduct, or the acts or conduct of any person or persons not party to or associated with Clearfield
6. Environmental factors and weathering resulting in aging and damage not necessary or applicable to the function of the product



Proprietary Notice

Information contained in this document is copyrighted by Clearfield, Inc. and may not be duplicated in full or part by any person without prior written approval of Clearfield, Inc.

Its purpose is to provide the user with adequately detailed documentation to efficiently install the equipment supplied. Every effort has been made to keep the information contained in this document current and accurate as of the date of publication or revision.

However, no guarantee is given or implied that the document is error free or that it is accurate with regard to any specification.

Technical Support

Clearfield, Inc. can be contacted for any issues that arise with the supplied product.

If you need to return the supplied product, you must contact the Clearfield, Inc. Customer Service Department to request a Returned Materials Authorization (RMA) number.

Clearfield, Inc.
7050 Winnetka Ave N
Minneapolis, MN 55428

Toll Free: 800.422.2537
Phone: 763.476.6866
Fax: 763.475.8457

Customer Support: sales@clfd.net
Technical Support: techsupport@clfd.net