

# YOURx-Aerial Terminal

*Installation Manual*

---



# YOURx-Aerial Terminal

## Installation Manual

---



<b>Table of Contents</b>	
<b>Application</b> .....	<b>3</b>
<b>Description</b> .....	<b>3</b>
<b>Technical Specifications</b> .....	<b>3</b>
<b>Components</b> .....	<b>4</b>
<b>Parts List</b> .....	<b>5</b>
<b>Recommended Tools</b> .....	<b>6</b>
<b>Strand Mounting</b> .....	<b>7</b>
<b>Accessing the YOURx-Aerial Terminal</b> .....	<b>8</b>
<b>Preparing FlexPorts for Drops</b> .....	<b>9</b>
<b>Installing Microduct and Push/Pull Fiber Drops</b> .....	<b>10</b>
<b>Installing FLATdrop and D-ROP with FlexConnector</b> .....	<b>11</b>
<b>Installing FlexPorts in the Field</b> .....	<b>12</b>
<b>Installing the Field Installable FlexConnector</b> .....	<b>13</b>
<b>Preparing End Plates for Splicing</b> .....	<b>15</b>
<b>Preparing Fiber Cables for Splicing</b> .....	<b>16</b>
<b>Splicing in the YOURx-Aerial Terminal</b> .....	<b>18</b>
<b>Splice Tray Setup</b> .....	<b>18</b>
<b>Ribbon</b> .....	<b>19</b>
<b>Loose Tube</b> .....	<b>21</b>
<b>6 Fiber 900 Micron Assembly</b> .....	<b>23</b>
<b>Drop Cable Options</b> .....	<b>24</b>
<b>Connector Cleaning Procedure</b> .....	<b>25</b>
<b>Standard Warranty</b> .....	<b>28</b>
<b>Proprietary Notice</b> .....	<b>29</b>
<b>Technical Support</b> .....	<b>29</b>

### Application

When the network deployment plan calls out for an aerial application, Clearfield's YOURx-Aerial Terminal application allows for the flexibility to terminate a feeder fiber, directly into revenue generating drops and has the capability to accommodate a fiber cable mid-span, allowing cables to be fully utilized while feeding multiple terminals and access points.

### Description

Designed with many of the same features as the YOURx-Terminal, the YOURx-Aerial Terminal allows for aerial or strand mount fiber deployment within the network architecture.

The YOURx-Aerial Terminal can accept the "hand-off" of fiber and distribute up to 24 individual service drops and has the capability to mid-span a larger count fiber cable, allowing the service provider to deploy multiple terminal/access points along the same cable run, maximizing the investment in fiber deployment.

Designed for easy, craft accessibility, the YOURx-Aerial Terminal application has an upward hinging, kickstand supported cover with four side entrance cable access ports. Two individual compartments separate the incoming splices from the drop ports for network security. The backplane of the unit has the capacity to hold up to three splice trays, incorporating fiber management and bend-radius protection into the design. Each splice tray supports 24 loose tube or 72 ribbon splices. With up to 24 individual drops terminated to SC or LC connectors, the YOURx-Aerial Terminal can accept all of the FieldShield® drop options, as well as other cable drop options.



### Technical Specifications

YOURx-Aerial Terminal - Patch and Splice	
Dimensions	14.80" W x 11.61" H x 8.15" D (height includes strand bracket)
Material	Black UV resistant Thermoplastic
Mounting Options	Aerial or Strand Mount
Internal Slack Storage	Up to 8 feet of ribbon (144 fiber); up to 8 feet of loose tube (144 fiber)
Feeder Ports	Four silicone sealed ports on ends of unit; two on each end
Distribution Ports	Up to 24 - 10 mm YOURx FlexPorts that accept FieldShield® Microduct or FLEXdrop connectors
Connector Types	SC/APC, SC/UPC, LC/APC, LC/UPC
Splicing Capabilities	24 loose tube or 72 ribbon splices per tray; three splice trays per terminal

# YOURx-Aerial Terminal

## Installation Manual



### Components

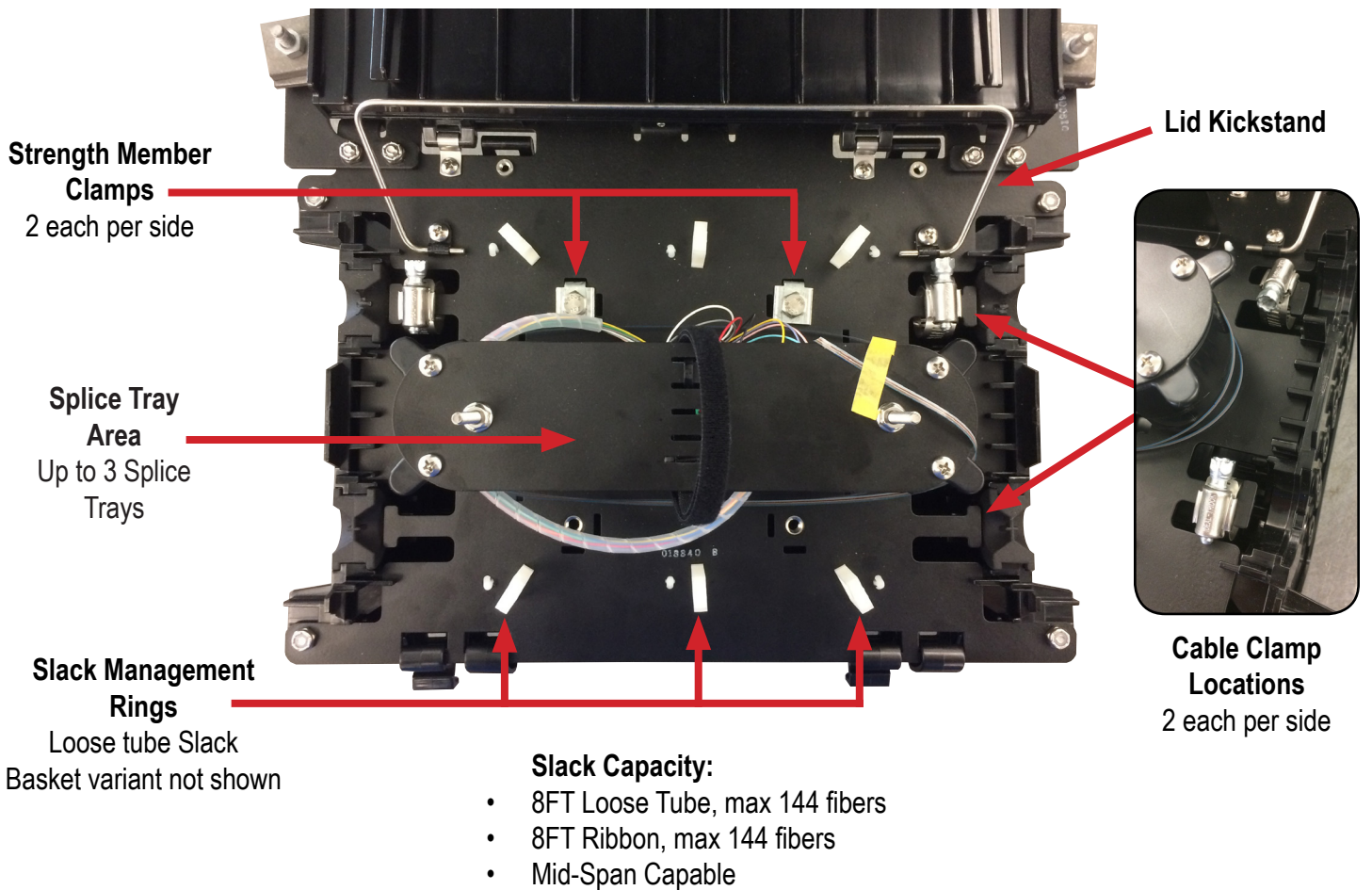
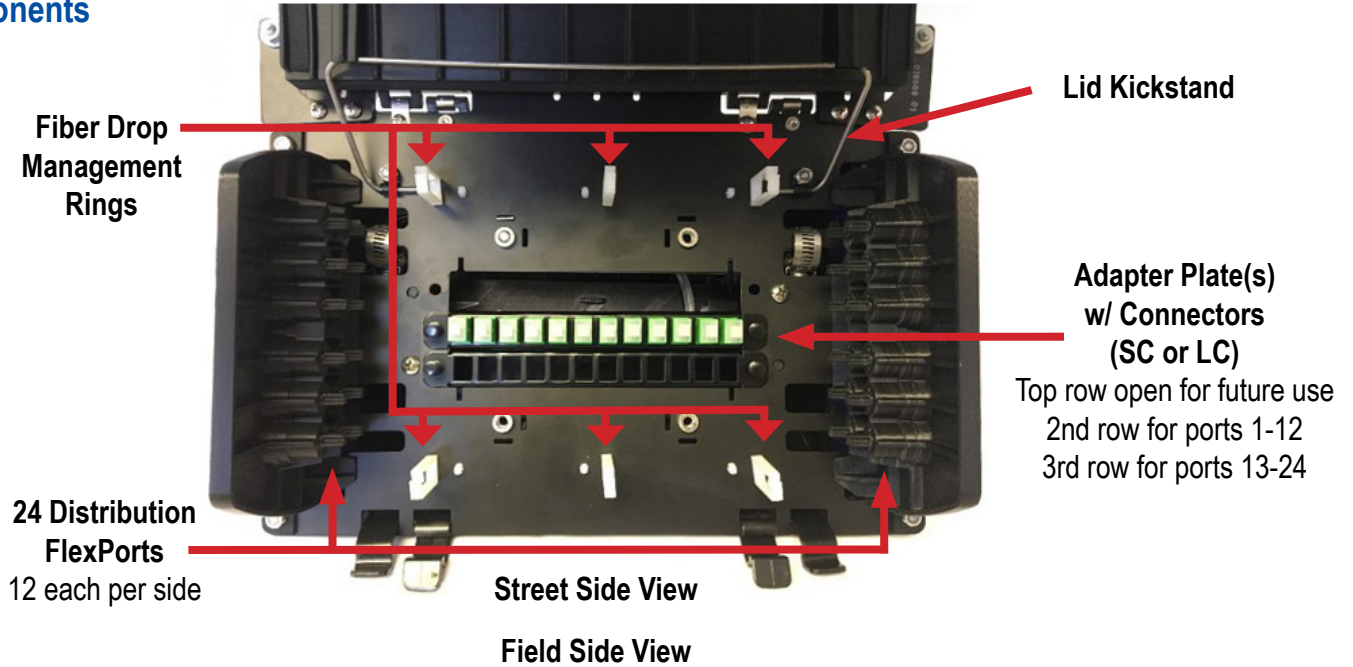

**GROUNDING AND BONDING: PER LOCAL PRACTICE**



### Parts List

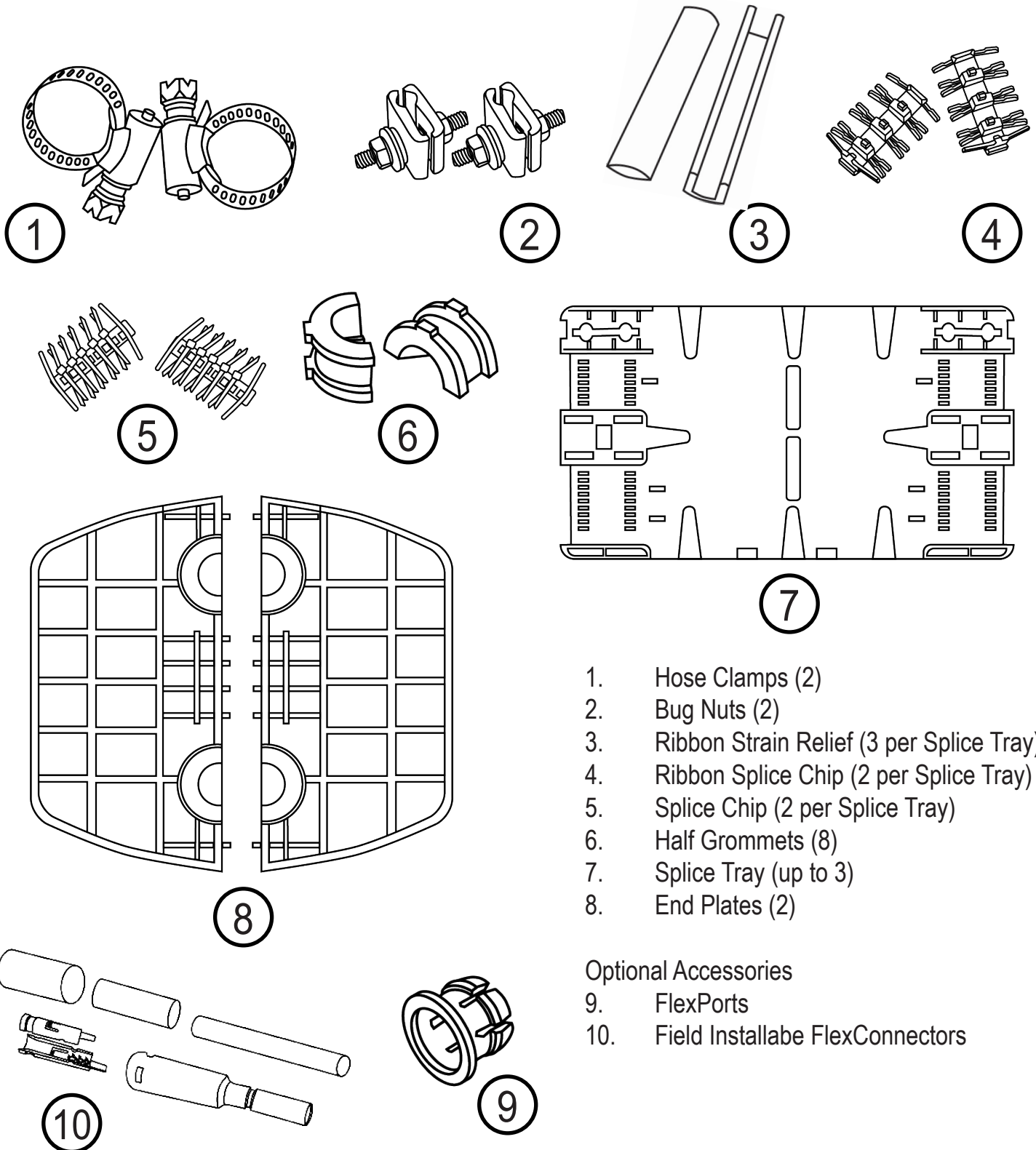

1. Hose Clamps (2)
2. Bug Nuts (2)
3. Ribbon Strain Relief (3 per Splice Tray)
4. Ribbon Splice Chip (2 per Splice Tray)
5. Splice Chip (2 per Splice Tray)
6. Half Grommets (8)
7. Splice Tray (up to 3)
8. End Plates (2)

#### Optional Accessories



9. FlexPorts
10. Field Installable FlexConnectors

# YOURx-Aerial Terminal

## Installation Manual

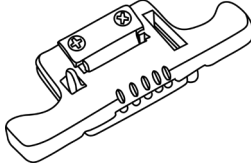
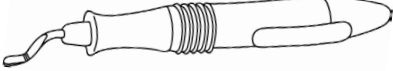
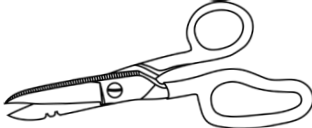
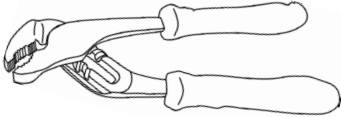
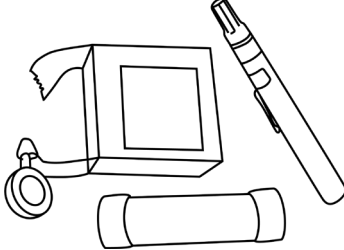
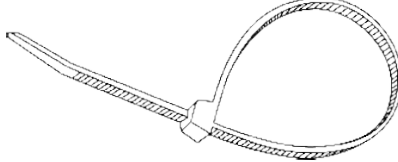

### Recommended Tools

Tool	Image
Mid-Span Access Tool	
De-burring Tool	
Snips	
Pliers	
Optical End Face Cleaning kit	
Small Cable Ties	
Cable Opening Tools	
Can Wrench	

## Strand Mounting

### Mounting YOURx-Aerial Terminal to strand options:

- A: Using provided mounting brackets and bug nuts
- B: Using optional adjustable mounting bracket

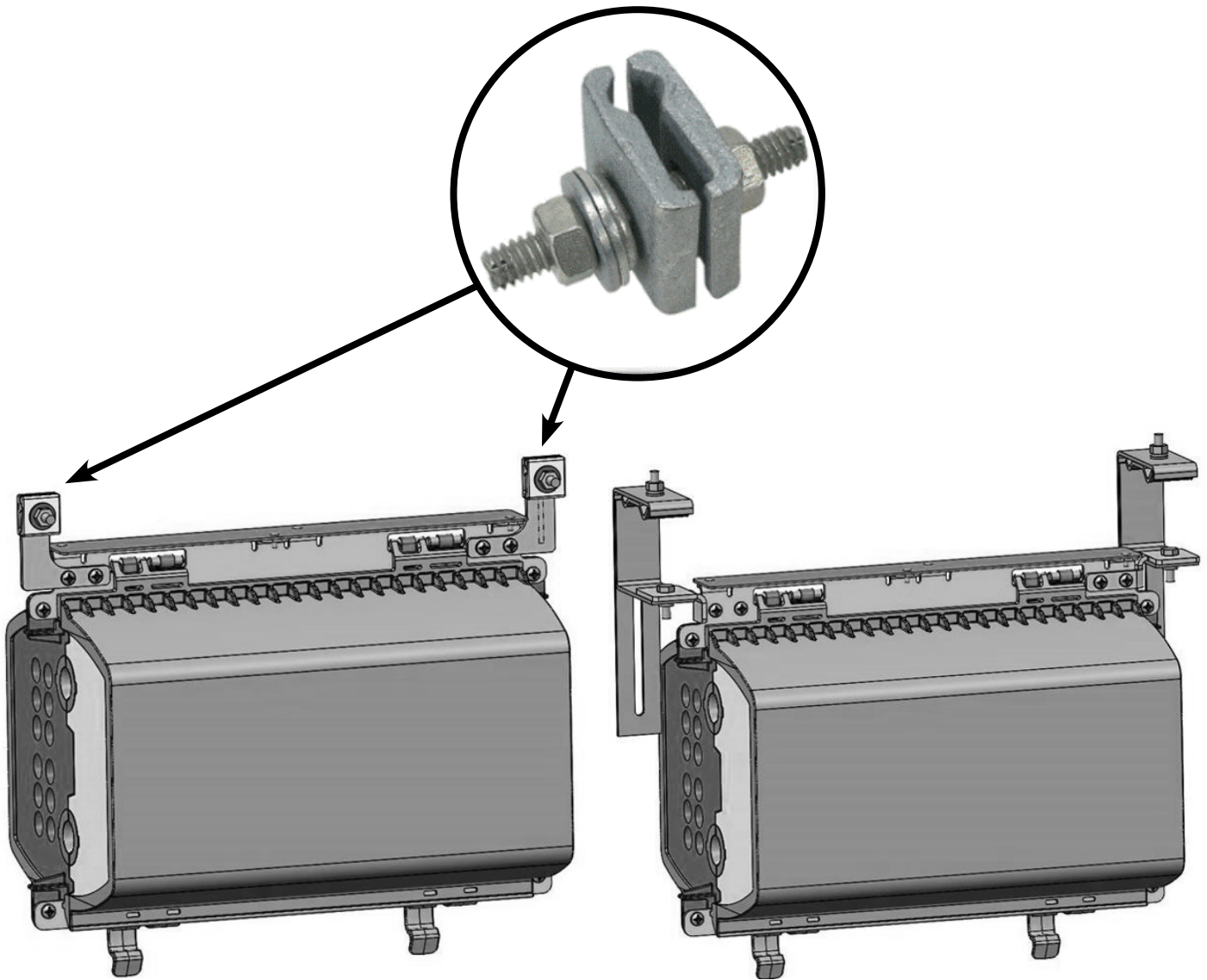

**A: Provided Mounting Bracket**

**B: Optional Bracket  
P/N: 019448**

# YOURx-Aerial Terminal

## Installation Manual



### Accessing the YOURx-Aerial Terminal

Each side of the YOURx-Aerial Terminal has a lid which is secured by two tabs. Release the tabs on one side in order to open the lid on that side. Close the lid and snap the tabs into place to secure it back in place.

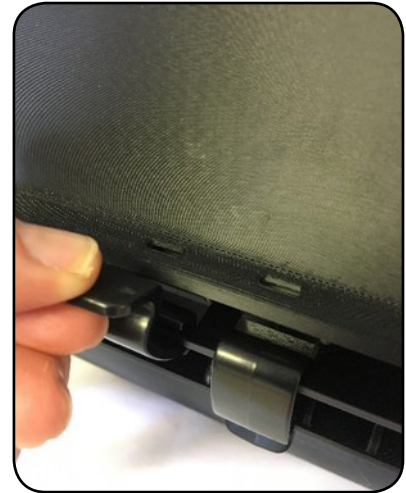

The lid on each side of the YOURx-Aerial Terminal can be propped open with the attached kickstand. Push the kickstand back and seat it under the tabs on the inside of the lid to prevent the lid from closing while the terminal is in use.

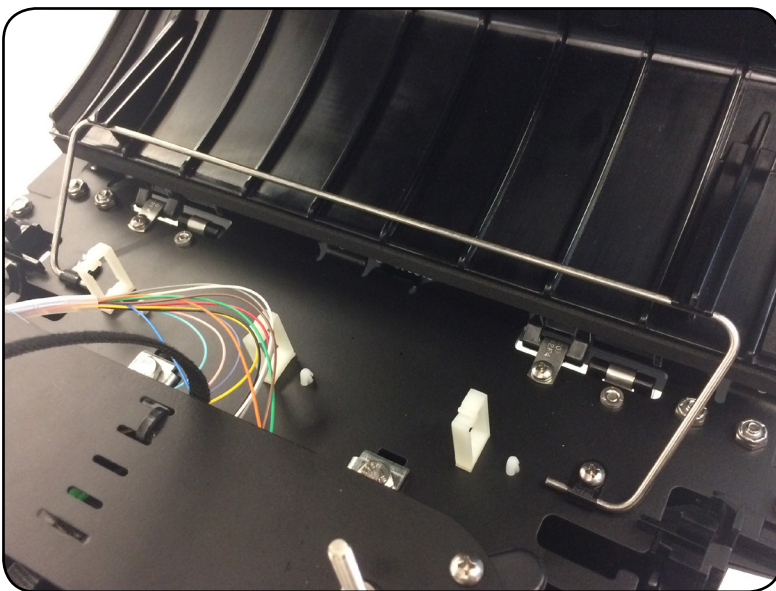



### Supports all FieldShield Drop Options

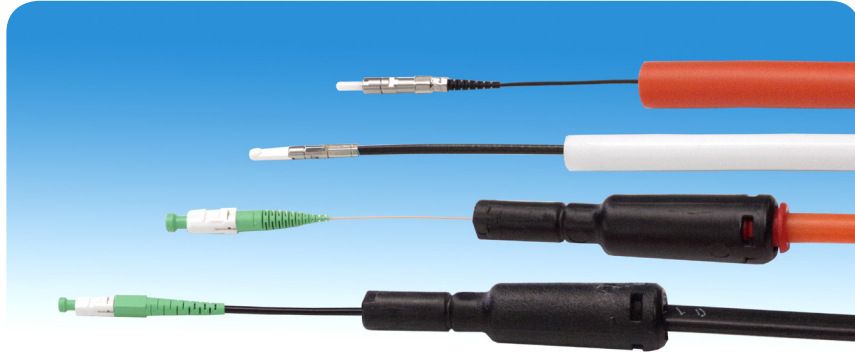

### Preparing FlexPorts for Drops

The terminal is available in a 6, 12 or 24 port drop configuration.

- Ports 1-12 will be on the left end plate, typically closest to the serving pole (unless specified differently, at ordering).
- Ports 13-24 on far end endplate

Useable FlexPorts will be marked with a silver "X" on the inside of port tab, indicating that a FlexPort has been installed and capable of accepting a water tight FlexConnector or microduct.



End Plate Interior



End Plate Exterior

**Step 1:** Using pliers, remove the tab from the desired port by bending and breaking the excess plastic away.

**Step 2:** De-burr (using a de-burring tool/snips/knife) the port hole for a smooth transition, helping to prevent damage to the fiber when it enters the port.





# YOURx-Aerial Terminal

## Installation Manual



### Installing Microduct and Push/Pull Fiber Drops

**Step 1:** De-burr the microduct, using the de-burring tool or similar device (snips or cable knife), creating a cone shape on the inside of the microduct for a smooth transition.

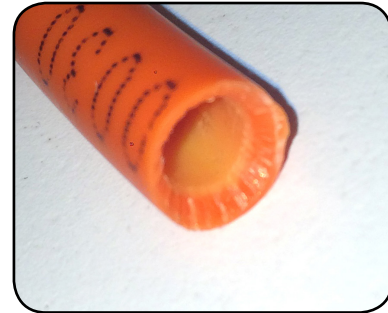
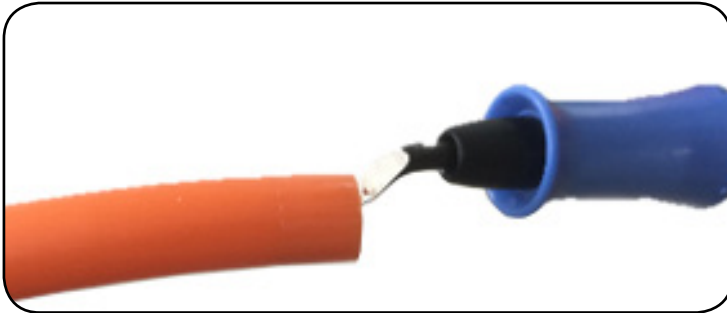

**Step 2:** Insert the pull string, if one is being utilized, through the FlexPort, and firmly seat the microduct into the FlexPort.

**Step 3:** Tie the pull string to the bulkhead until you are ready to pull in a fiber drop.



**Step 4:** After pulling fiber into terminal, complete the "Pushable Connector" housing as instructed with the specific connector being utilized.

**Step 5: Inspect Then Connect!** Follow our recommended Connector Cleaning Procedures included in this manual for a reliable connection.

**Step 6:** Make the connection to the assigned port.

**Step 7:** Route slack around fiber drop management rings.



### Installing FLATdrop and D-ROP with FlexConnector

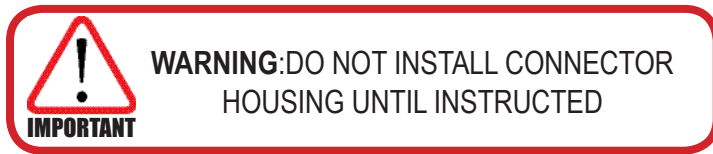

**Step 1:** Push the YOURx breakout with SC connector assembly (FLATdrop or D-ROP) through FlexPort.

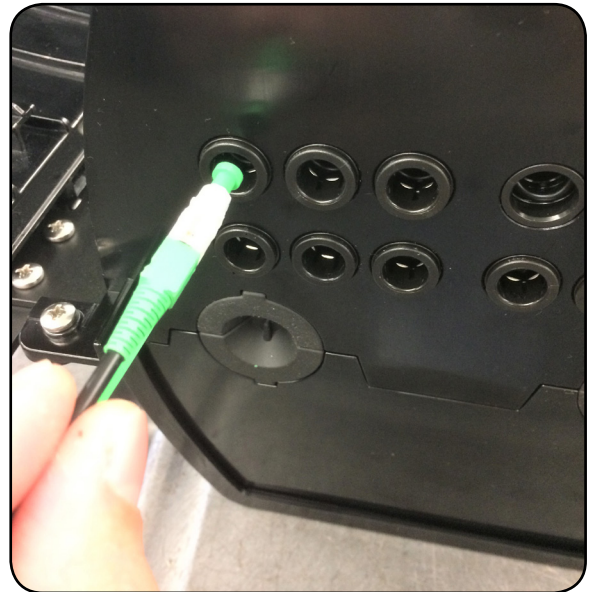

**Step 2:** Firmly seat the FlexConnector (FLATdrop or D-ROP) into the FlexPort.

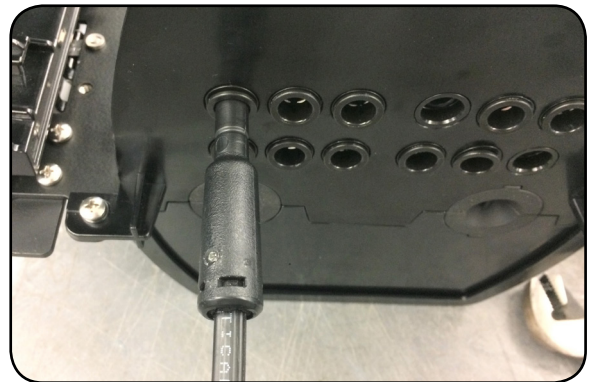

**Step 3:** After pulling fiber into terminal, complete the "Pushable Connector" housing as instructed.

**Step 4: Inspect Then Connect!** Follow our recommended Connector Cleaning Procedures included in this manual for a reliable connection.

**Step 5:** Route slack around fiber drop management rings.





# YOURx-Aerial Terminal

## Installation Manual



### Installing FlexPorts in the Field

On the outside of terminal, at the desired port, insert the FlexPort pieces as shown.

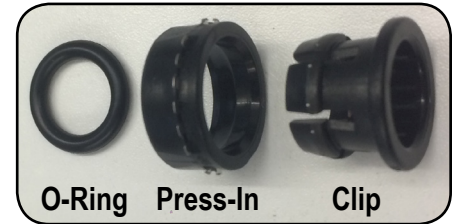

**Step 1:** Insert an O-ring into the desired port. Push the O-ring all the way into the port, as far back as it will go. Make sure it lies flat in the port.



**Step 2:** Insert the "Press-In" piece into the port after the O-ring. Be sure to place the Press-In into the port tapered side first, with the teeth side facing outwards. Press hard or **gently** tap it into place with a tool, as needed, until it sits fully flush.

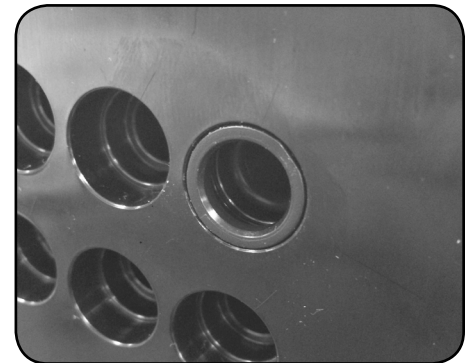

**Step 3:** Install the "Clip" piece of the FlexPort into the Press-In. It should click into place. Once installed, Clips should be loose, not springy. If you notice the Clip being pushed out, re-adjust the O-ring.



### Installing the Field Installable FlexConnector

**Step 1:** Prep cable to YOURx length (14 inches) cutting strength members flush with black, outer cable sheath.



**Step 2:** For water tight seal, feed the following three lengths of heat shrink onto cable for later use:

- (1) 3/4" x 2 1/4" long (004867)
- (1) 1/2" x 2 1/4" long (004644)
- (1) 5/16" x 3" long (004458)



**Step 3:** Pass breakout 3mm cable through FlexConnector.



**Step 4:** Stop short of cable sheath.



**Step 5:** Align nose of clips to end of black cable and sandwich together.

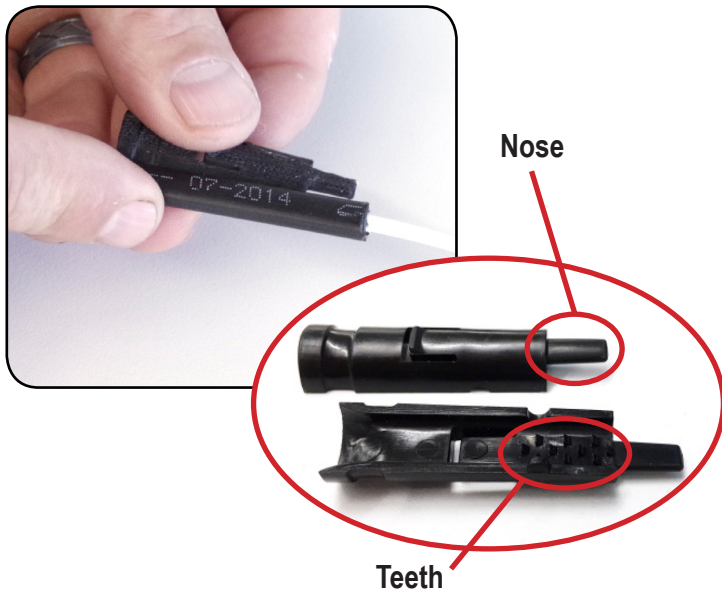

**Step 6:** Attach clips to top and bottom of cable, teeth in, even at cable sheath opening. A groove on the clip allows for proper alignment.

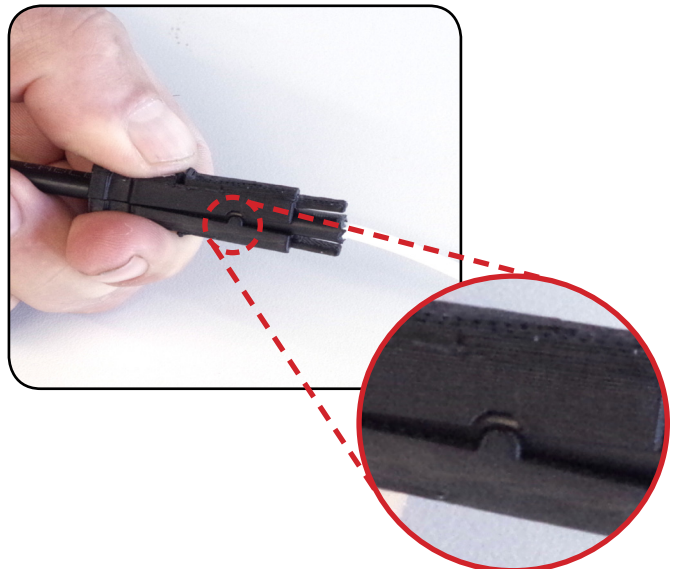

# YOURx-Aerial Terminal

## Installation Manual



**Step 7:** Use pliers (as shown) to pinch teeth to hold jacket.

**DO NOT** use needle nose pliers.

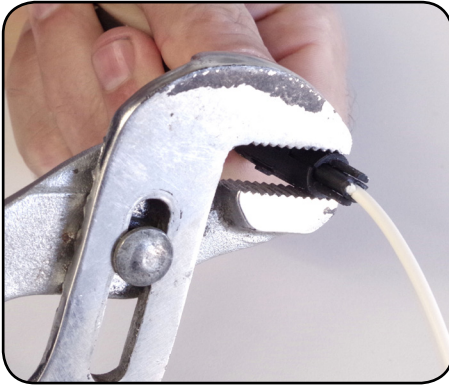

**Step 8:** Pull FlexConnector (added in Step 3) back over clips to snap into FlexConnector holes, as shown. Push until you hear a snap.

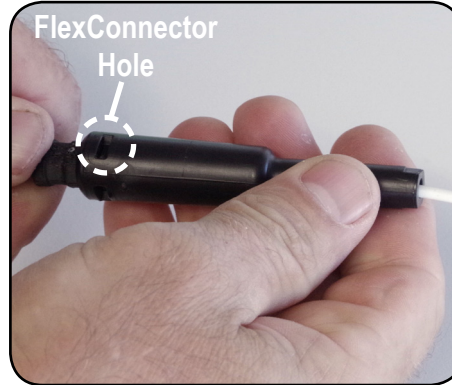

**Step 9:** Slide the 3" piece (004458) heat shrink tubing, placing one end just inside the back end of the FlexConnector. Shrink using a heat gun.



**Step 10:** Place smaller diameter heat shrink (004644) covering rear of clips and heat to shrink.



**Step 11:** Finish with the largest heat shrink (004867) covering the holes on the FlexConnector and heat to shrink.



**Step 12:** Terminate fiber to connector per instructions (if applicable).

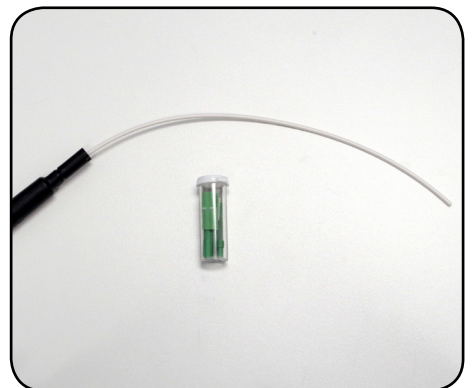

This will create a water tight seal.



### Preparing End Plates for Splicing

**Step 1:** Locate the two end plates.

**Step 2:** Position all four of the cable entrance  $\frac{1}{2}$  grommets in the end plates.

**Step 3:** For each cable entrance that will be used, trim the compression grommet to fit the cable being utilized (up to  $\frac{3}{4}$  inch outer diameter) as shown.

**Note:** It may be easier to trim the grommets to size before inserting them into the end plates.

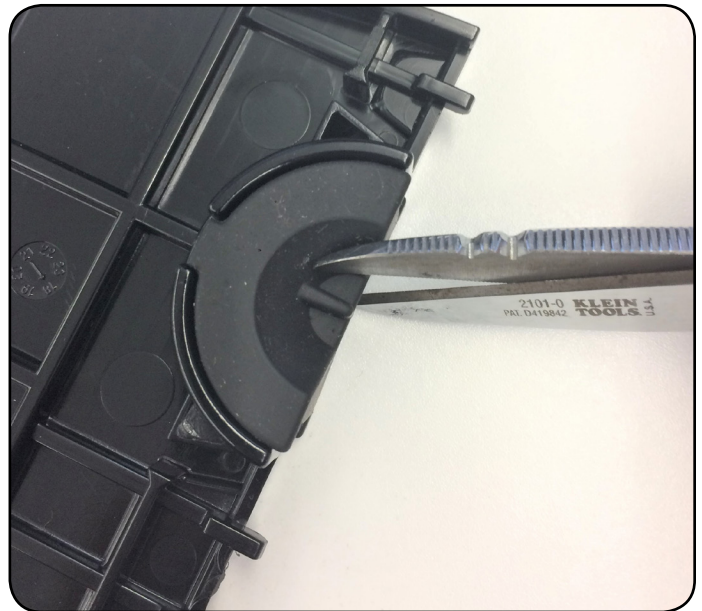
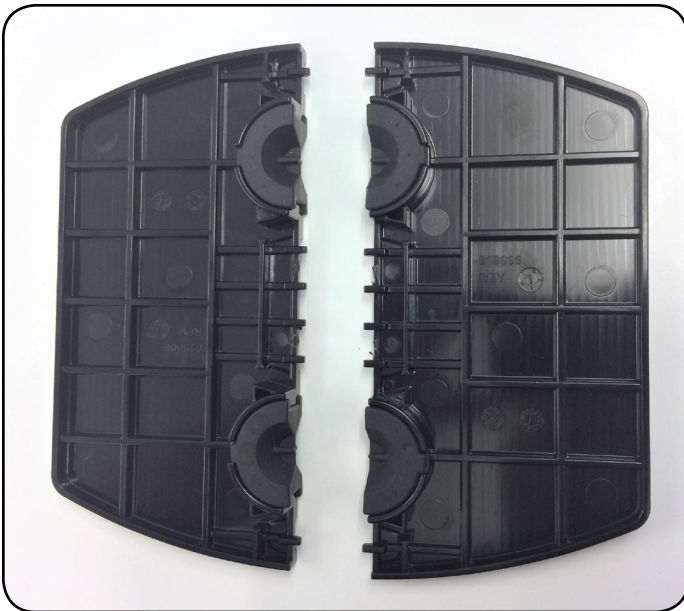

### Preparing Fiber Cables for Splicing

**Step 1:** Open the cable to expose the buffer tubes/ribbons for splicing, mid-spanning the cable if applicable.

**Note:** Max cable opening for a 144 fiber loose tube cable will be 11 feet (132 inches), 8 feet (96 inches) of slack and 3 feet (36 inches) for splicing in the splice tray.

**Step 2:** Trim the cable's strength member, on each end if mid-spanning, to approximately 3 inches.

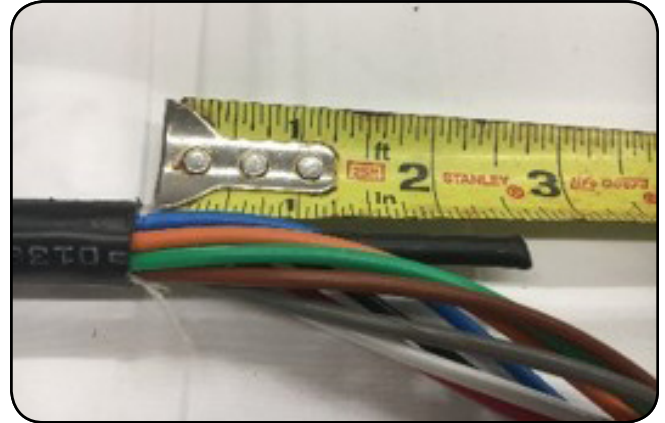

**Step 3:** Trim the remaining cable entrance 1/2 grommets to fit the cable(s) you will be bringing in (max outer diameter 3/4"). If no cable will be present in an entrance location, leave the grommets untrimmed, but still insert them into their locations in the end plates.

**Step 4:** Place the cable into the terminal at the chosen cable entrance/exit, making sure that the compression grommet is set into the end plate behind.

**Step 5:** Slide the strength member into the clamp and secure it in place.

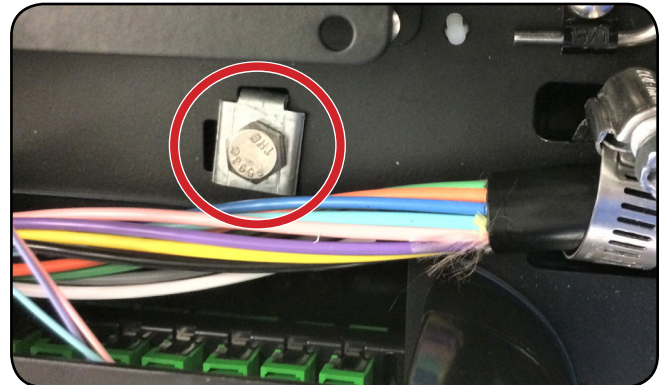

**Step 6:** Place the provided hose clamp over the cable and tighten, securing it in place to the bulkhead. The cable jacket opening should be located at least 1/4" past the hose clamp.

**Note:** If mid-spanning/expressing cable, complete steps 4-6 again on the other end of the cable opening.

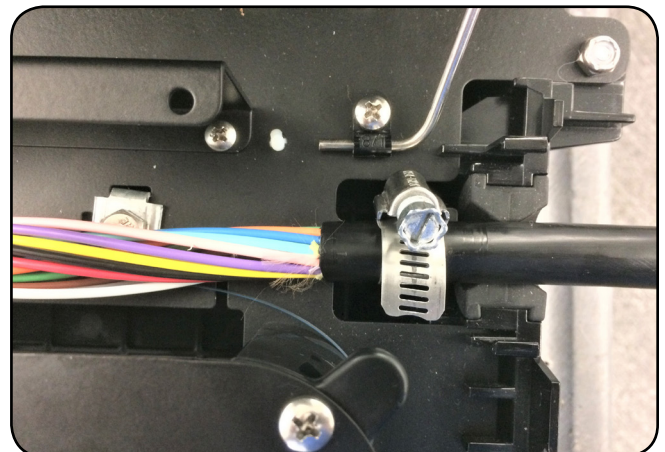



**Step 7:** Once all cables are loaded into terminal, place the end plates on each side of terminal. Placing the ribbed side of plate to the inside, press the end plate until it locks into place, ensuring the top and bottom 1/2 grommets are located in all 4 cable entrance locations.

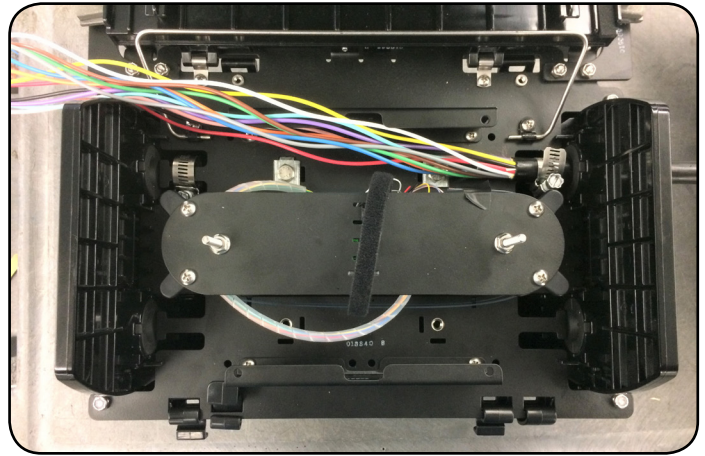
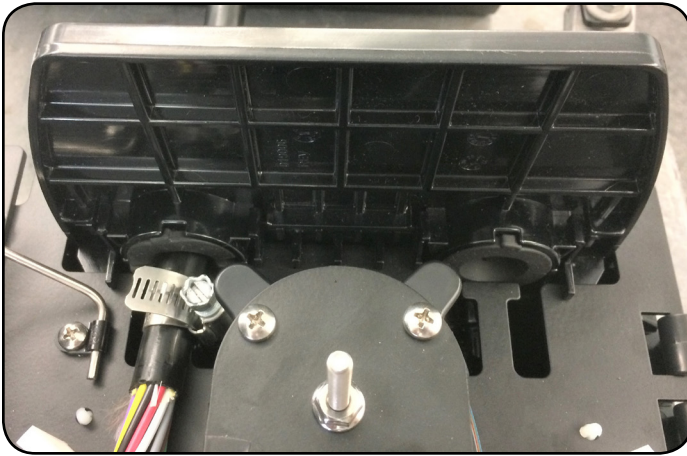

**Step 8:** From the newly installed cable bundle, remove the buffer tube/ribbons that will be spliced in the splice tray and set them aside. Store the remaining buffer tubes/ribbons in the slack management basket (buffer tubes) or rings (ribbon).

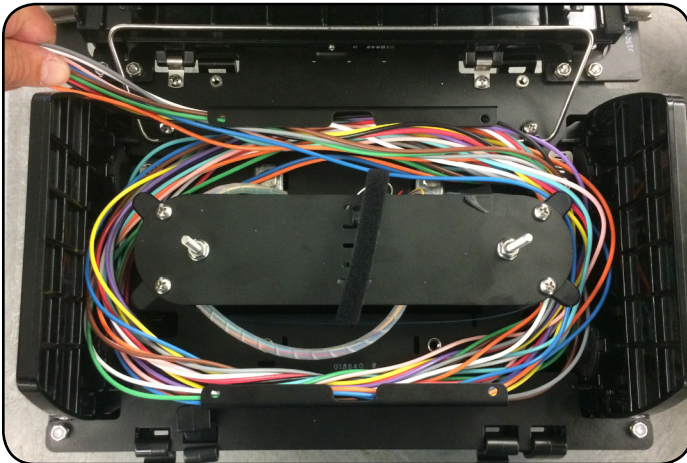

**Buffer Tube**

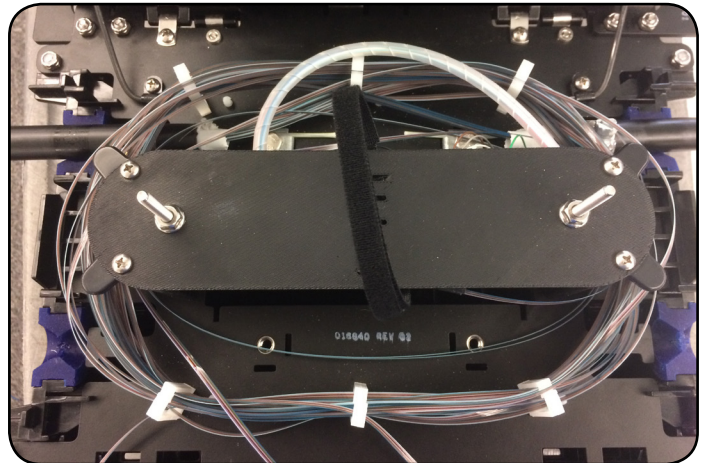

**Ribbon**

**Step 9:** Store 2-3 wraps of the buffer tubes/ribbons you intend to splice, slack that will be used to bring the splice tray and fibers to your workspace and perform the splices.

**Step 10:** Clearfield recommends an additional 3ft/1m of fiber after the 2-3 slack wraps, which will be used for splicing in the splice tray.

**Step 11:** Remove the slack wraps of the ribbons/buffer tubes you intend to splice.

# YOURx-Aerial Terminal

## Installation Manual



### Splicing in the YOURx-Aerial Terminal

#### Splice Tray Setup

Splice trays (P/N 019339) will be shipped with 2 standard splice chips and 2 ribbon splice chips, allowing for a total of 24 loose tube splices or 6 ribbon mass fusion splices (72 fibers). Splice chips will need to be gently bent, placing both ends into the empty slots in the center of the splice tray.

**Note:** Each standard splice chip features 6x2 splice sleeve slots, allowing for 12 splice sleeves to be stacked 2 high in the 6 slots. Each ribbon splice chip features 3 ribbons splice sleeve slots, as well as one 2 high loose tube splice sleeve slot for use in special applications or repairs.

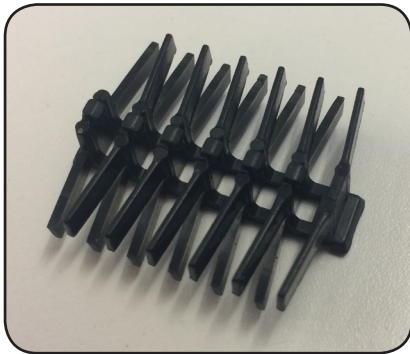

**Splice Chip**

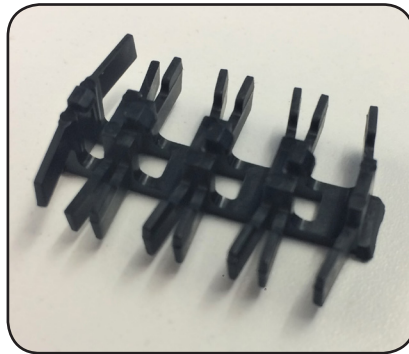

**Ribbon Splice Chip**



**Bending the Splice Chip**

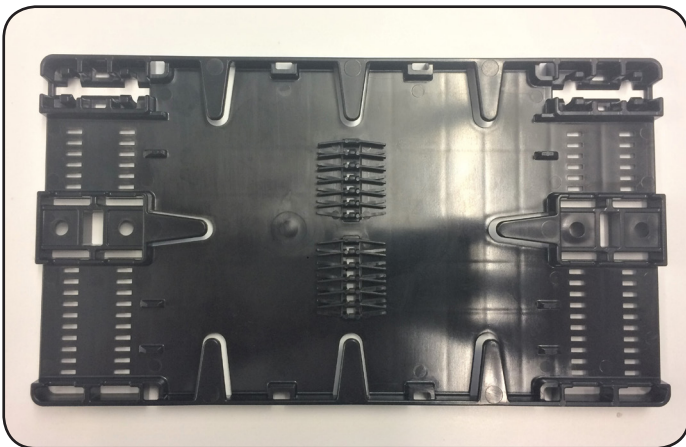

**Splice Tray Loaded with  
2 Splice Chips**

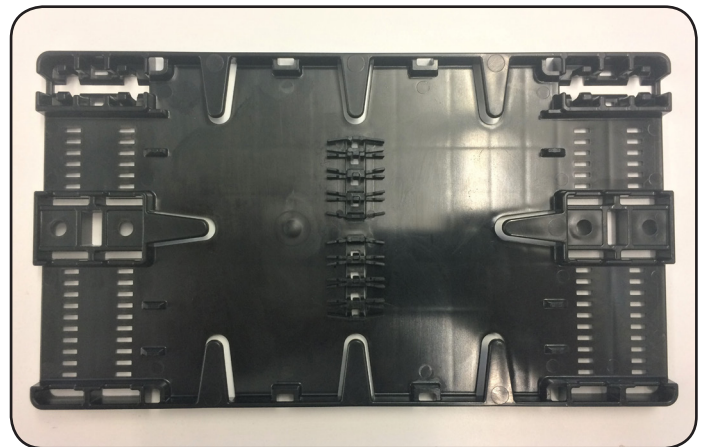

**Splice Tray Loaded with  
2 Ribbon Splice Chips**



### Ribbon

**Step 1:** Bring the ribbon fibers you wish to splice to the splice tray in your workspace.

**Note:** Provided with the splice tray are 3 ribbon tie-downs which utilize a split grommet and u-channel (plastic retention cover) which will allow the ribbon to be secured into the tray even in mid-span/ring cut applications.

**Step 2:** 3ft from the end, slip the split rubber grommet onto the ribbon, followed by the u-channel over the opposite side.

**Note:** Extra ribbon tie-downs are available in a kit, which can be ordered separately (P/N 019501).

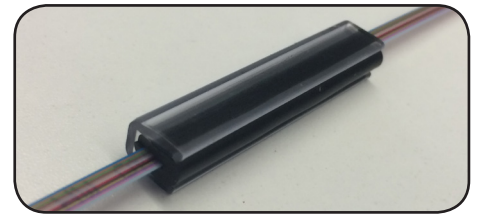
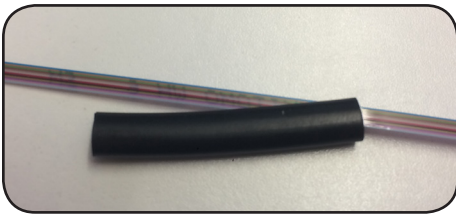

**Step 3:** After protecting the ribbon fiber with the ribbon tie-down, secure it into the tray using small cable ties.

**Note:** The splice tray features tie-down holes on each side of the tray, which will allow for 5 ribbon tie-downs per side, in addition to one ribbon tie down on each side in the assembly fiber location.

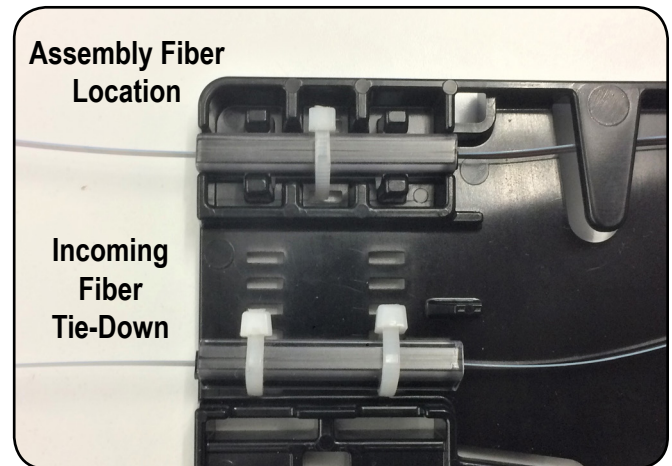

**Step 4:** Remove the 5 meter ribbon fiber assembly that is wrapped around the center spools below the splice tray area and taped to the top. 24 fiber configurations will arrive with two 12 fiber ribbons.

**Step 5:** Bring the fiber assembly to the splice tray in your workplace and secure it into the splice tray in the same manner as you did for your incoming ribbon fiber.

**Note:** Clearfield recommends leaving 3ft/1m after the ribbon tie down for use in splicing in the splice tray.

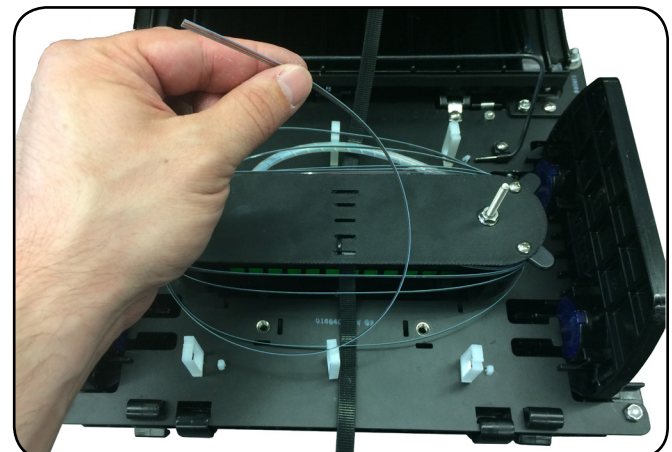



# YOURx-Aerial Terminal

## Installation Manual



**Step 6:** Perform your splices, securing the ribbon splice sleeves in the ribbon splice chips in the center of the splice tray.

**Step 7:** Reinstall the splice tray cover.

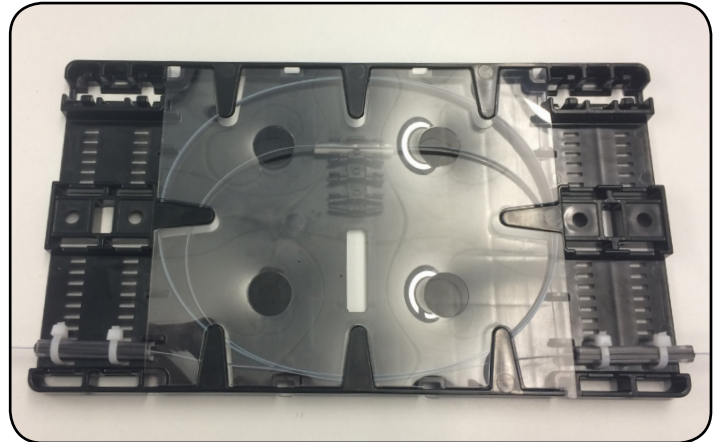
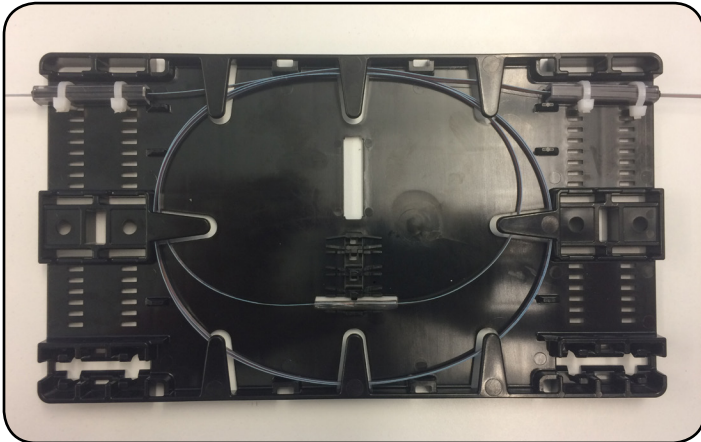

**Step 8:** Place the splice tray into the splice tray area, allowing the two threaded studs to pass through the holes on each side of the splice tray.

**Step 9:** Re-store the extra slack used to reach your work space into the fiber management rings.

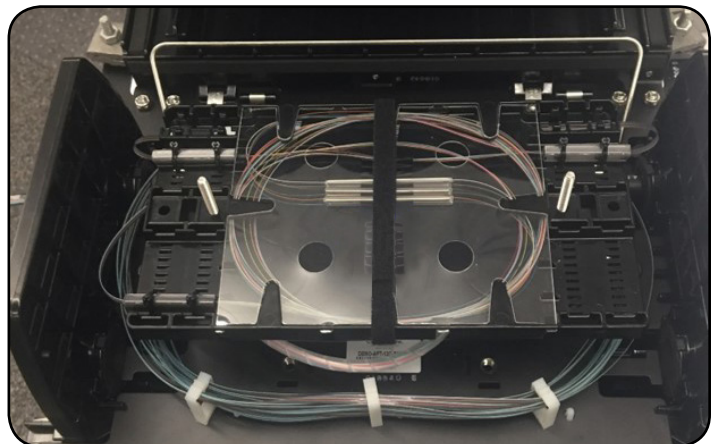

**Step 10:** Secure the splice tray(s) in place with the provided velcro strap and two wing nuts, which will go on the two threaded studs.

**Note:** The YOURx-Aerial Terminal can hold up to three splice trays.

**Step 11:** Close the YOURx-Aerial Terminal, latching the lid shut.

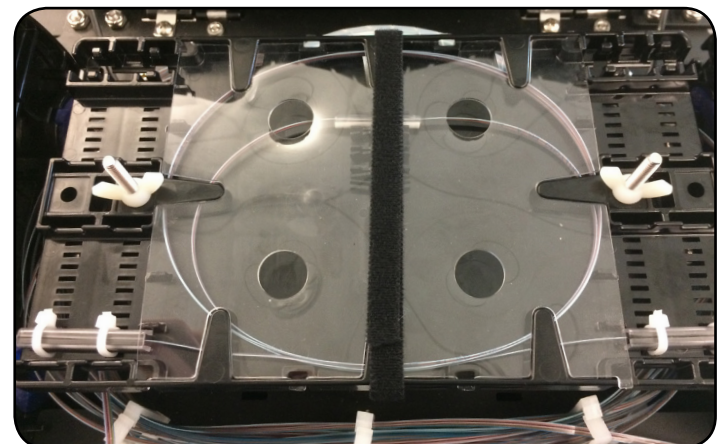

### Loose Tube

**Step 1:** Bring the buffer tubes you wish to splice to the splice tray in your workspace.

**Note:** A maximum of 24 loose tube splices can be completed in each splice tray.

**Step 2:** Wrap one layer of grommet tape around the buffer tube, 3 feet (1 meter) back from the end of the tube. Trim the excess grommet tape.

**Step 3:** Open the buffer tube roughly 1/4 inch after the grommet tape, being careful not to damage the loose tube fibers.

**Note:** If expressing fibers in the buffer tube, remove approximately 3ft/1m of the buffer tube in a window, protecting the buffer tube on the other side with grommet tape in the same manner as shown here.

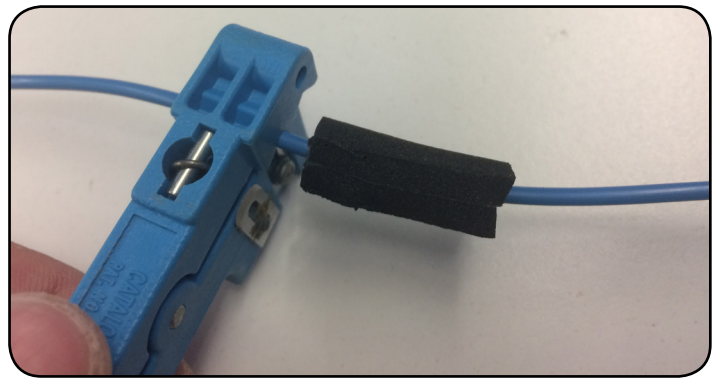
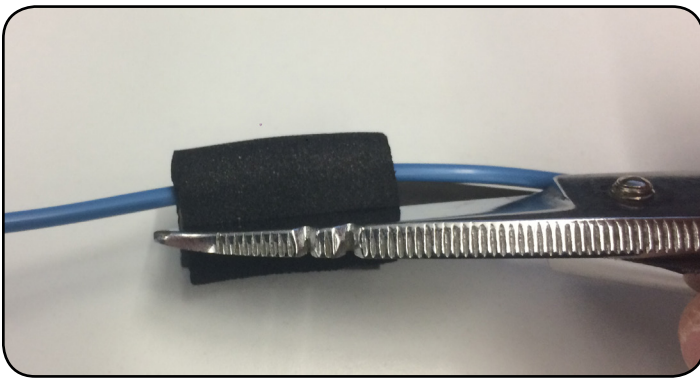

**Step 4:** Using two small cable ties, secure the buffer tube into the splice tray.

**Note:** When using cable ties/zip ties to secure fibers, do not use excessive force! Take care not to damage fibers.

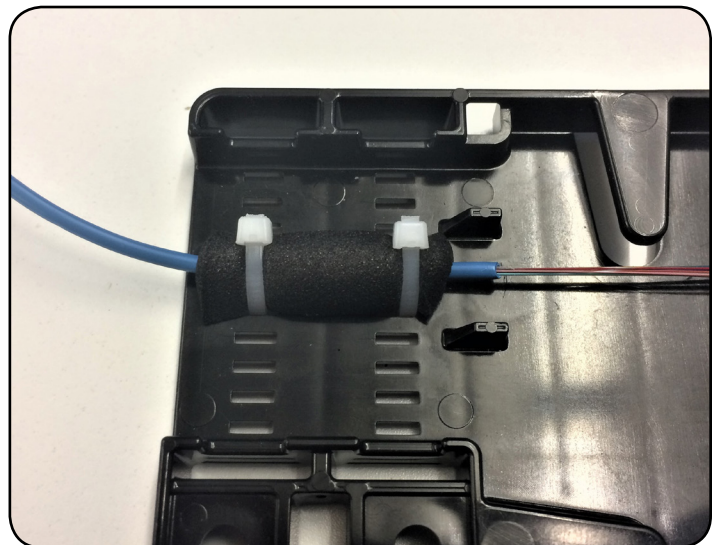

# YOURx-Aerial Terminal

## Installation Manual



**Step 5:** Remove the 5m pre-loaded fiber assembly from the central spools of the terminal and bring it to your workspace.

**Note:** In loose tube splicing applications, the fiber assembly will consist of a 5m ribbon which has been de-laminated for the last meter, resulting in twelve 250 micron loose tube fibers which will be taped to the top of the splice tray area.

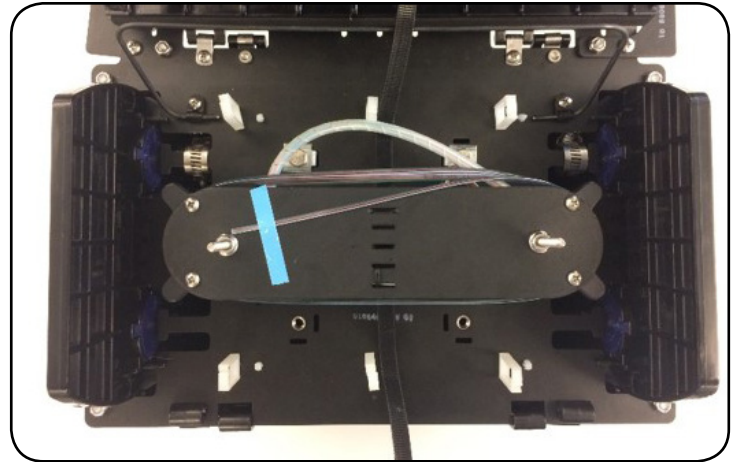

**Step 6:** To secure the pre-loaded fiber assembly into the splice tray, refer back to the ribbon splicing section of this manual. You will be using the split grommet and u-channel to secure the ribbon, just before it is broken out into loose tube, into the splice tray.

**Step 7:** Perform your splices, stacking the splice sleeves two high in the splice chips located in the center of the splice tray.

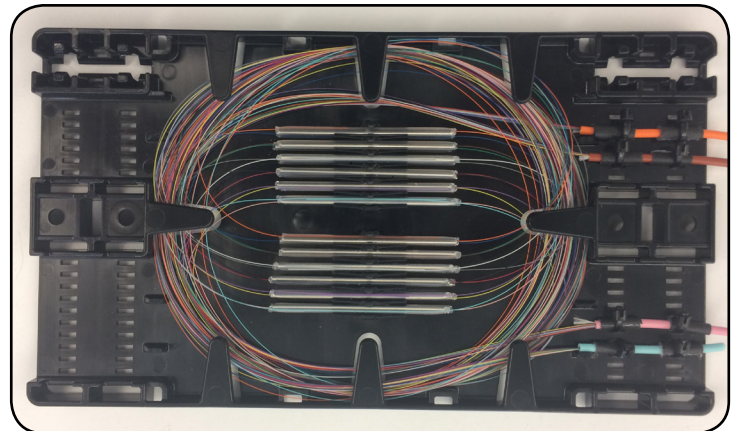

**Step 8:** After splicing is complete, replace the splice tray cover.

**Step 9:** Bring the splice tray back to the YOURx-Aerial Terminal, placing the splice tray into the terminal by sliding the two mounting holes on the tray over the two threaded studs in the splice tray area.

**Note:** Consult the ribbon splicing section of this manual for images.

**Step 10:** Route the excess slack, which was used to access the work space, back into the slack basket surrounding the splice tray area of the terminal.

**Step 11:** Secure the splice tray(s) (up to 3) in place with the provided velcro strap and two wing nuts, which will go on the two threaded studs.

**Step 12:** Close the YOURx-Aerial Terminal, latching the lid shut.



### 6 Fiber 900 Micron Assembly

**Step 1:** Gather the six 900 $\mu$ m fibers and measure approximately 3ft/1m from the end. Mark the fibers with a permanent marker.

**Step 2:** Fold a piece of grommet tape around the fibers at the mark you made, and trim the excess.

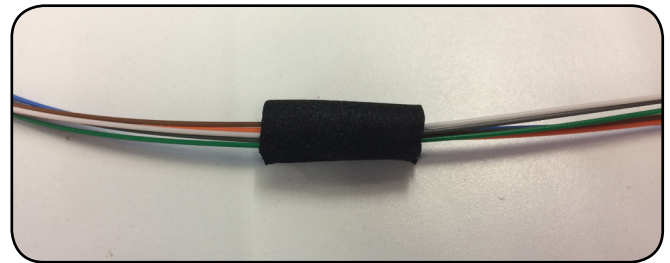
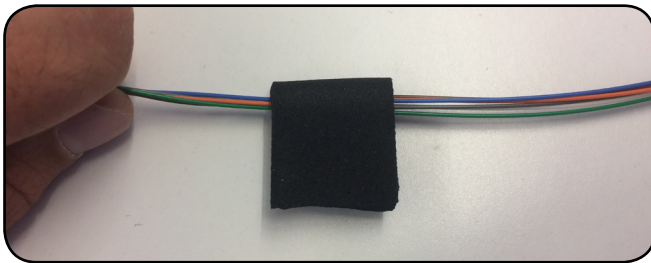

**Step 3:** Place two small cable ties into the holes in the splice tray on the side you wish to secure the assembly.

**Note:** You will mirror all these steps being done for your incoming fibers with the pre-loaded fiber assembly.

**Step 4:** GENTLY secure the bundle of 900 $\mu$ m fibers into the tray. DO NOT secure too tightly or you will damage the fibers.

**Step 5:** Perform your splices, stacking splice sleeves in the splice chip in the center of the splice tray.

**Step 6:** Replace the splice tray cover. Place the splice tray back into the terminal, sliding the holes in the splice tray over the two threaded studs in the splice tray area.

**Note:** Refer to the ribbon splicing section of this manual for images showing these steps.



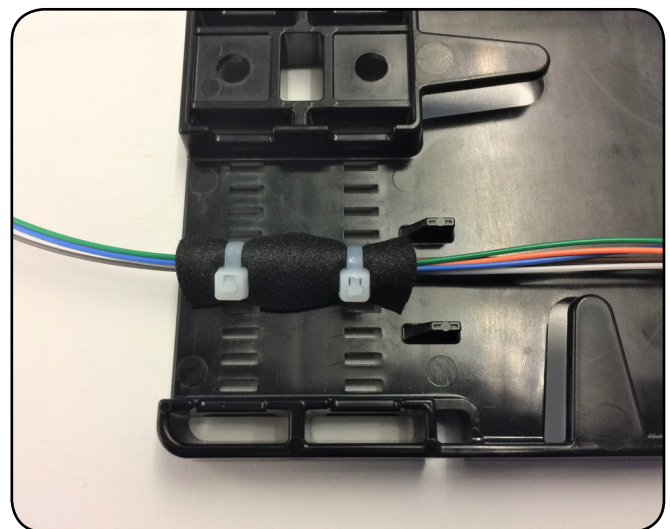
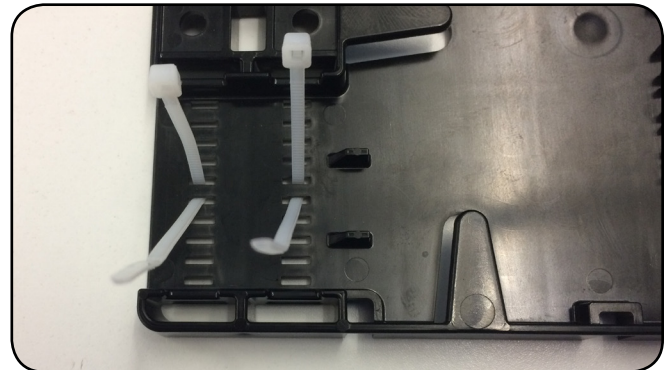

**Step 7:** Route the excess slack used to reach the work space back into the YOURx-Aerial Terminal.

**Step 8:** Secure the splice tray(s) (up to 3) back into the terminal with the provided velcro and wing nuts on each threaded stud.

**Step 9:** Close the YOURx-Aerial Terminal, latching the lid shut.



### DROP CABLE OPTIONS

Product Name	Cable Jacket	UV	Temperature	FieldShield Connector	Jacket Color	Can be stapled	Best Application
FieldShield FLATdrop 	Outdoor	Yes	-40° to 176°F	No	Black	Yes	For use when fast installation and low up-front cost is most desired feature.
FieldShield D-ROP 	Outdoor	Yes	-40° to 176°F	Yes	Black/ Orange	Yes	For use when a single pass and restorable solution at a competitive price is ideal.
FieldShield FLEXdrop 	Indoor (Plenum)/ Outdoor	Yes	-40° to 176°F	Yes	Black/ White	Yes	For use when a premium product that has maximum workability, flexibility and restorability is desired.
FieldShield (Classic) 	Outdoor in Duct	Yes in Duct	-40° to 176°F	Yes	Black	Yes	For use when the distance from the access point to the SFU/MDU is longer than normal and a more rigid solution is required to maintain restorability for drops longer than 300 feet.
FieldShield StrongFiber 	Indoor/ Outdoor in Duct	Yes in Duct	-40° to 176°F	Yes	Black	Yes in Duct	For use when a reusable pathway is needed and maximum slack storage is desirable.



## Connector Cleaning Procedure

Whether factory terminated or field spliced, clean connectors are essential for proper system operation. Even the smallest dust particle can cause transmission problems, so for optimal network performance inspect, and if necessary, clean connectors and adapters prior to mating.

### Inspect Then Connect

These are Clearfield recommended products/applications. Use the product you feel will complete your cleaning procedures. Create a “best practice” for your company and follow those procedures.

The use of Chemtronics end face and bulkhead cleaning products and techniques ensures a clean end face, no matter the type of contamination.

Before cleaning any connector, be sure you know what type of contaminate you are cleaning (dry, fluidic, or combination). All the available products are good, it's the process that you need to be aware of. Using a dry cleaning method to clean “dirt” can lead to scratching of the end face. Learn the process of cleaning properly.

**Note:** It is **NOT** recommended to use isopropyl alcohol to clean the end face.

## Cleaning an SC/LC Connector

### Cleaning the End Face

- Place one wiping paper on QbE-2 FiberSafe™ Cleaning Platen. (Figure 1)
- Apply small amount of precision cleaner (about 1” in diameter) with Electro-Wash MX pen on to one end of the wipe. (Figure 2)
- Hold end face at a 90 degree angle. For APC connection, adjust by slightly tilting the container or end face. Angle is correct when no drag is felt on the end face. (Figure 3)
- Draw end face from wet to dry part of the wipe 3 times. Use just enough pressure to ensure complete contact between end face and the wipe.

**Note:** **DO NOT** retrace previous step.



Figure 1



Figure 2



Figure 3

### Cleaning the Ferrule

- Lightly moisten the fiber optic swab (2.5mm/38542F or 1.25mm/38040) by spotting a small amount (about 1") of Electro-Wash PX or Electro-Wash MX pen onto the QbE. Hold the swab, 1 side down to the wetted area and hold for a count of 1-2-3-4-5. (Figure 4)

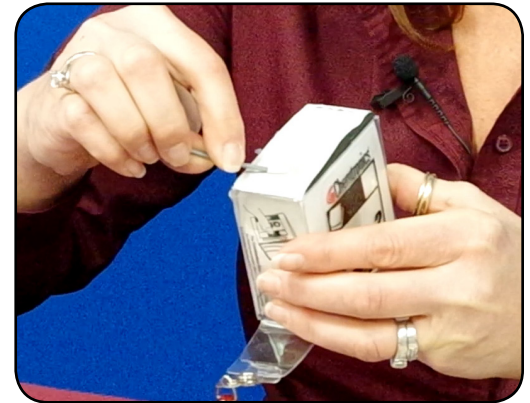

Figure 4

- Insert swab into side of ferrule, wet side to the ceramic ferrule and circle around 2-3 times and remove. Turn swab to dry side and repeat. (Figure 5)



Figure 5

### Cleaning the Mate Through an Adapter AND the Adapter Itself

- Lightly moisten the fiber optic swab (2.5mm/38542F or 1.25mm/38040) by spotting a small amount (about 1") of Electro-Wash PX or Electro-Wash MX pen onto the QbE. Hold the tip of the swab onto the wetted area and hold for a count of 1-2-3-4-5.
- Insert the swab into the adapter to the connector, press lightly against the connector, twist 2-3 times, remove and discard.
- Dry with a second dry swab.
- Inspect, repeat cleaning if necessary, and test for signal strength.
- Use additional swabs to clean inside the actual adapter. Moisten swab, like above, and insert through hole and remove while twisting. (Figure 6)

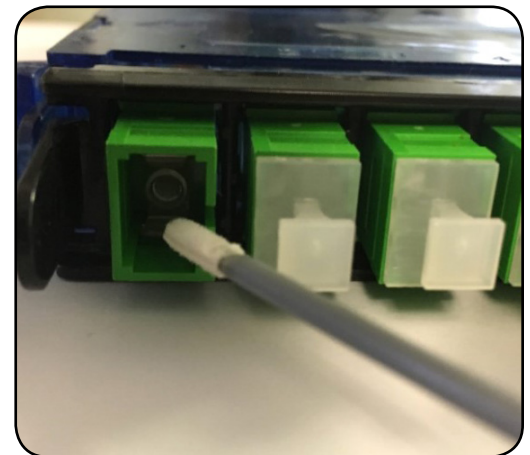

Figure 6

## Cleaning an MPO/MTP Connector

### Female Connector

- Place one wiping paper on QbE-2 FiberSafe™ Cleaning Platen and apply small amount of precision cleaner (about 1" in diameter) with Electro-Wash MX pen on to one end of the wipe. **(Figure 1)**



Figure 1

- Hold end face at a 90 degree angle. For APC connection, adjust by slightly tilting the container or end face. Angle is correct when no drag is felt on the end face. **(Figure 2)**

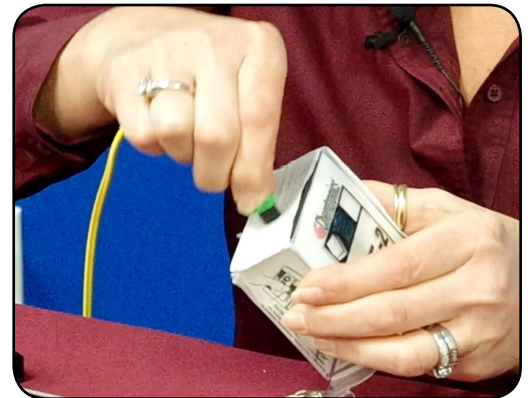

Figure 2

### Male Connector

- Lightly moisten one side of the fiber optic swab (CC505F) by spotting a small amount (about 1") of Electro-Wash PX or Electro-Wash MX pen onto the QbE. Hold the swab, 1 side down to the wetted area and hold for a count of 1-2-3-4-5.
- Place swab, wet side down, at one end of connector end face and draw across in a diagonal sweep; i.e., from fiber 1 up and across to fiber 12. Turn swab over to dry and draw back from fiber 12 to fiber 1. **(Figure 3)**



Figure 3



### Standard Warranty

Clearfield warrants to the original purchaser of the Product sold hereunder is free from defects in material and workmanship under normal use and service, subject to exceptions stated herein. Product purchased is warranted as follows: Clearfield designed and branded Products are warranted for three (3) years; Products manufactured by Clearfield to customer prints and/or specifications are warranted for one (1) year; and any Product Clearfield acquires from or through a third-party manufacturer or distributor and resells to Customer as the original customer will carry the manufacturer's pass-through warranty, if any. In all cases, the warranty period commences on the date of shipment to the original purchaser.

### Warranty Claim Procedure

If any Product purchased from Clearfield is found defective under the above warranty, the following basic procedure must be followed:

1. Customer must contact Clearfield and obtain a Return Materials Authorization.
2. Following authorization, the Customer ships the product-freight collect to Clearfield's manufacturing facility.
3. Clearfield shall repair or replace the defective Product at its sole option and discretion, and return the repaired or replacement Product to Customer's site, freight prepaid.

Note: If the Product is not found to be defective by Clearfield, the product will be returned to the Customer and the customer billed for freight in both directions.

View our warranty policy here: <https://www.seeclearfield.com/warranty.html>

### Limitations of Warranty

Correction of defects by repair or replacement, at the option of Clearfield Inc, shall constitute the exclusive sole remedy for a breach of this limited warranty. Clearfield shall not be liable under any circumstances for any special, consequential, incidental, punitive, or exemplary damages arising out of or in any way connected with the product or with agreement to sell product to buyer, including, but not limited to damages for lost profits, loss of use, or for any damages or sums paid by buyer to third parties. The foregoing limitation of liability shall apply whether the claim is based upon principles of contract, warranty, negligence or other tort, breach of statutory duty, principles of indemnity or contribution, the failure of any limited or exclusive remedy to achieve its essential purpose, or otherwise.

Clearfield will not be responsible for any labor or materials costs associated with installation or incorporation of Clearfield products at customer sites, including any costs of alteration, replacement or defective product, or any field repairs.

### Other Limitations

Clearfield assumes no warranty liability regarding defects caused by:

1. Customer's modification of Product, excepting installation activities described in Clearfield documentation.
2. Customer re-packaging of Product for shipment to third parties or destinations other than those originally shipped to by Clearfield, or any defects suffered during shipping where the Product has been re-packaged.
3. Customer's installation or maintenance, excepting activities described in and performed in accordance with Clearfield documentation
4. Customer's improper or negligent use or application of Product.
5. Other causes external to the Product, including but not limited to accidents, catastrophe, acts of God, government action, war, riot, strikes, civil commotion, sovereign conduct, or the acts or conduct of any person or persons not party to or associated with Clearfield.
6. Environmental factors and weathering resulting in aging and damage not necessary or applicable to the function of the product.



# YOURx-Aerial Terminal

## *Installation Manual*

---

### Proprietary Notice

Information contained in this document is copyrighted by Clearfield, Inc. and may not be duplicated in full or part by any person without prior written approval of Clearfield, Inc.

Its purpose is to provide the user with adequately detailed documentation to efficiently install the equipment supplied. Every effort has been made to keep the information contained in this document current and accurate as of the date of publication or revision.

However, no guarantee is given or implied that the document is error free or that it is accurate with regard to any specification.

### Technical Support

Clearfield, Inc. can be contacted for any issues that arise with the supplied product.

If you need to return the supplied product, you must contact the Clearfield, Inc. Customer Service Department to request a Returned Materials Authorization (RMA) number.

Clearfield, Inc.  
7050 Winnetka Ave N  
Minneapolis, MN 55428

Toll Free: 800.422.2537  
Phone: 763.476.6866  
Fax: 763.475.8457

Customer Support: [sales@clfd.net](mailto:sales@clfd.net)  
Technical Support: [techsupport@clfd.net](mailto:techsupport@clfd.net)